



**BEMETApreisliste2026**







# preisliste2026

## PRICE LIST

### BEMETA

#### INHALT CONTENTS

	<b>AURIA/GLACERA</b>	2
	<b>BRILIA/GRINO</b>	3
	<b>ZYRA/COPRA</b>	4
	<b>DELTA</b>	5
	<b>NIA</b>	6 - 7
	<b>ORGANIC/ORGANIC BLACK</b>	8 - 9
	<b>GALLA</b>	10
	<b>OMEGA</b>	11 - 17
	<b>NEO</b>	18 - 20
	<b>CORAL/AMBER</b>	21
	<b>BRILO/SABLO</b>	22
	<b>HEMATIT/GRAPHIT</b>	23
	<b>WHITE/DARK</b>	24- 27
	<b>OBLA/STELLA</b>	28
	<b>CIRCUM /QUADRA</b>	29
	<b>NERO</b>	30 - 31
	<b>LIVING</b>	32
	<b>NIVA</b>	33
	<b>VIA</b>	34 - 35
	<b>SOLO</b>	36
	<b>GAMMA</b>	37 - 38
	<b>NIKI</b>	39
	<b>BETA</b>	40 - 42
	<b>EASY/EASY01</b>	43 - 45
	<b>ALFA/NOX</b>	46
	<b>RETRO</b>	47 - 49
	<b>CYTRO</b>	50 - 53
	<b>RAWELL</b>	54
	<b>VISTA</b>	55
	<b>ELEKTRISCHE HANDTUCHTROCKNER</b> HEATED TOWEL RAILS	56 - 58
	<b>DUSCHRINNEN</b> SHOWER DRAINS	59
	<b>KOSMETIKSPIEGEL UND SPIEGEL</b> COSMETIC MIRRORS AND MIRRORS	60 - 63
	<b>ÖFFENTLICHER RAUM</b> PUBLIC SPACES	64 - 80
	<b>DUSCHZUBEHÖR</b> SHOWER PROGRAM	81 - 82
	<b>HELP PROGRAMM</b> HELP PROGRAM	83 - 97
	<b>ERSATZTEILE</b> SPARE PARTS	98 - 103
	<b>ZUBEHÖR</b> ACCESSORIES	104

#### ERKLÄRUNGEN ANNOTATION

	<b>Neue</b> New
	<b>Wandmontage - Bohren.</b> Wall mounted - drilling.
	<b>Wandmontage - Kleben.</b> <b>Set 199352010 nicht enthalten (siehe Seite 104).</b> Wall mounted - gluing. Set 199352010 not included (see on page 104).
	<b>Produkt mit Klebetape, nicht zum bohren!</b> The product is provided with adhesive tape, no drill.
	<b>Oberflächenbehandlung gegen Fingerabdrücke.</b> Fingerprint-resistant surface finish.
	<b>Zertifiziert.</b> Certified.
	<b>Belastbarkeit</b> Load capacity
	<b>Bis zum Ausverkauf</b> Till sold out.
	<b>Speditionsartikel - Direktlieferung per Spedition ab Werk.</b> Bitte beachten Sie das LKW Symbol bei den Speditionsartikeln in der Preisliste. Frachtaufschlag nach Deutschland je Palette: Frachtaufschlag nach Luxemburg je Palette:

€ 65,00  
€ 100,00

**Die genannten Preise ohne MwSt. sind ab dem 1. 1. 2026 gültig.**  
Prices are valid from 1. 1. 2026.

# auria / GLacera

 171XXXXXX

 175XXXXXX

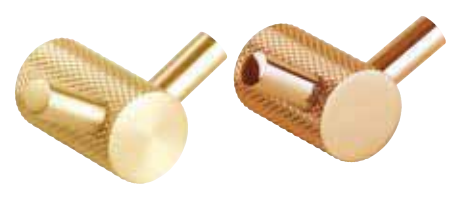
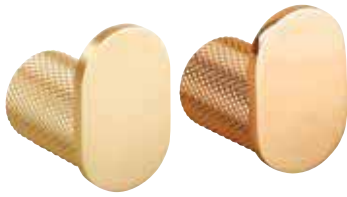

material  
material

Messing  
brass

Edelstahl  
stainless steel

Glas  
glass

Oberflächenfinish  
Surface finish

PVD



gebürstet  
brushed

PVD



poliert  
polished

## Kleiderhaken

Single robe hook

28×45×39 mm

171206020

175206020



34,00 €

34,00 €

## Kleiderhaken

Single robe hook

25×39×40 mm

171106020

175106020

## Doppelkleiderhaken

Double robe hook

58×32×40 mm

171106030

175106030



28,00 €

28,00 €



37,00 €

37,00 €

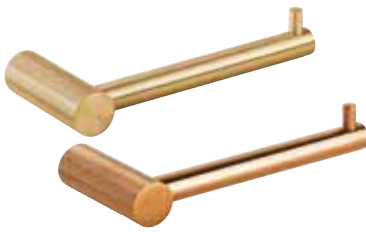

## Toilettenpapierhalter

Toilet paper holder

160×34×72 mm

171212030

175212030



69,00 €

69,00 €

## Toilettenpapierhalter mit Deckel

Toilet paper holder with cover

136×132×82 mm

171112012

175112012



108,00 €

108,00 €

## WC-Bürstengarnitur, hängend

Wall mounted toilet brush holder

115×352×135 mm

171113010\*

175113010\*



109,00 €

109,00 €



## Glaseifenschale

Soap dish

109×47×117 mm

171108040

175108040



67,00 €

67,00 €

## Zahnglshalter

Toothbrush holder

68×94×98 mm

171110010

175110010



67,00 €

67,00 €

## Seifenspender

Soap dispenser

68×143×113 mm, 200 ml

171109010

175109010



138,00 €

138,00 €

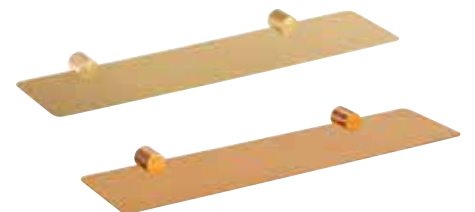

## Handtuchhalter

Towel holder

628×28×64 mm

171204020

175204020



134,00 €

134,00 €

## Handtuchring

Ring towel holder

178×182×55 mm

171204060

175204060



69,00 €

69,00 €

## Metallablage

Metal shelf

450×25×130 mm

171204022

175204022



131,00 €

131,00 €

\* weiße Bürste/white brush

# Brilia / grino

177XXXXXX

173XXXXXX



## Kleiderhaken

Single robe hook

28x45x39 mm

177206020

173206020



32,00 €

34,00 €

## Kleiderhaken

Single robe hook

25x39x40 mm

177106020

173106020



25,00 €

28,00 €

## Doppelkleiderhaken

Double robe hook

58x32x40 mm

177106030

173106030



32,00 €

37,00 €

material  
material

Messing  
brass

Edelstahl  
stainless steel

Glas  
glass

Oberflächenfinish  
Surface finish

Chrom  
chrome

poliert  
polished

PVD

gebürstet  
brushed



## Toilettenpapierhalter

Toilet paper holder

160x34x72 mm

177212030

173212030



46,00 €

69,00 €

## Toilettenpapierhalter mit Deckel

Toilet paper holder with cover

136x132x82 mm

177112012

173112012



69,00 €

108,00 €

## WC-Bürstengarnitur, hängend

Wall mounted toilet brush holder

115x352x135 mm

177113010\*

173113010\*



80,00 €

109,00 €



## Glasseifenschale

Soap dish

109x47x117 mm

177108040

173108040



53,00 €

67,00 €

## Zahnglshalter

Toothbrush holder

68x94x98 mm

177110010

173110010



53,00 €

67,00 €

## Seifenspender

Soap dispenser

68x143x113 mm, 200 ml

177109010

173109010



115,00 €

138,00 €



## Handtuchhalter

Towel holder

628x28x64 mm

177204020

173204020



118,00 €

134,00 €

## Handtuchring

Ring towel holder

178x182x55 mm

177204060

173204060



50,00 €

69,00 €

## Metallablage

Metal shelf

450x25x130 mm

177204022

173204022



110,00 €

131,00 €

\* weiße Bürste/white brush

# zyra / COPra

 174XXXXXX

 176XXXXXX

material  
material

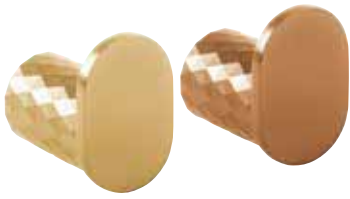

Messing  
brass

Edelstahl  
stainless steel

Glas  
glass

Oberflächenfinish  
Surface finish

PVD



poliert  
polished

PVD



gebürstet  
brushed

## Kleiderhaken

Single robe hook

28×45×39 mm

174206020

176206020



34,00 €

34,00 €

## Kleiderhaken

Single robe hook

25×39×40 mm

174106020

176106020



28,00 €

28,00 €

## Doppelkleiderhaken

Double robe hook

58×32×40 mm

174106030

176106030



37,00 €

37,00 €

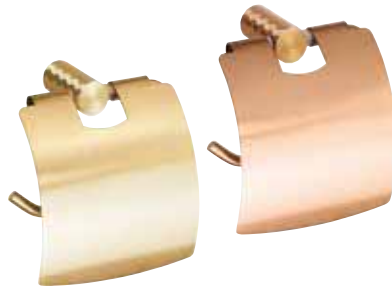
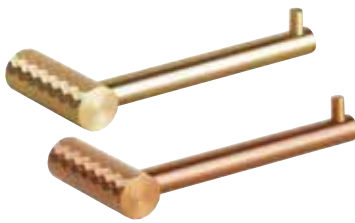

## Toilettenpapierhalter

Toilet paper holder

160×34×72 mm

174212030

176212030



69,00 €

69,00 €

## Toilettenpapierhalter mit Deckel

Toilet paper holder with cover

136×132×82 mm

174112012

176112012



108,00 €

108,00 €

## WC-Bürstengarnitur, hängend

Wall mounted toilet brush holder

115×352×135 mm

174113010\*

176113010\*



109,00 €

109,00 €



## Glaseifenschale

Soap dish

109×47×117 mm

174108040

176108040



67,00 €

67,00 €

## Zahnglshalter

Toothbrush holder

68×94×98 mm

174110010

176110010



67,00 €

67,00 €

## Seifenspender

Soap dispenser

68×143×113 mm, 200 ml

174109010

176109010



138,00 €

138,00 €

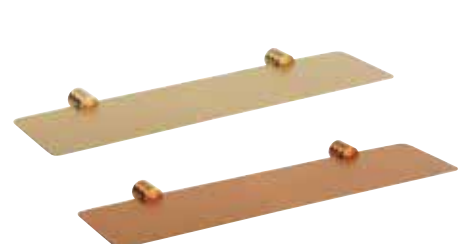

## Handtuchhalter

Towel holder

628×28×64 mm

174204020

176204020



134,00 €

134,00 €

## Handtuchring

Ring towel holder

178×182×55 mm

174204060

176204060



69,00 €

69,00 €

## Metallablage

Metal shelf

450×25×130 mm

174204022

176204022



131,00 €

131,00 €

\* weiße Bürste/white brush



**Doppelkleiderhaken**  
Double robe hook  
97×21×45 mm  
181006032

42,00 €



**Glasseifenschale**  
Soap dish  
120×22×105 mm  
181008022

103,00 €



**Toilettenpapierhalter**  
Toilet paper holder  
144×92×36 mm  
181012222

108,00 €



**WC-Bürstengarnitur, hängend**  
Wall mounted toilet brush holder  
87×410×105 mm  
181013012\*

185,00 €



**Zahnglashalter**  
Toothbrush holder  
86×114×116 mm  
181011012

104,00 €



**Seifenspender**  
Soap dispenser  
86×134×116 mm, 200 ml  
181009042

123,00 €



**Handtuchring**  
Ring towel holder  
250×147×61 mm  
181004062

139,00 €



**Handtuchhalter**  
Towel holder  
600×32×60 mm  
181004042

232,00 €



**Glasablage**  
Glass shelf  
600×19×129 mm  
181002242

114,00 €

\* weiße Bürste/white brush

- material
- Edelstahl  
stainless steel
- Zink  
zinc
- Glas  
glass
- Oberflächenfinish  
Surface finish
- Chrom  
chrome
- poliert  
polished

material  
material

Messing  
brass

Glas  
glass

Oberflächenfinish  
Surface finish

gebürstet  
brushed



**Kleiderhaken**  
Single robe hook  
17×38×30 mm  
180006015

31,00 €



**Doppelkleiderhaken**  
Double robe hook  
37×26×30 mm  
180006235

27,00 €



**Doppelkleiderhaken**  
Double robe hook  
80×28×39 mm  
180006035

33,00 €

180012025



180012025L



**Toilettenpapierhalter**

Toilet paper holder  
179×28×59 mm  
180012025  
180012025L

37,00 €  
37,00 €



**Toilettenpapierhalter mit Deckel**  
Toilet paper holder with cover  
130×95×90 mm  
180012015

68,00 €



**Toilettenpapierhalter**  
Toilet paper holder  
131×90×75 mm  
180012225

49,00 €



**Reservetoilettenpapierhalter**

Spare toilet paper holder  
20×178×59 mm  
180112035

44,00 €



**Reservetoilettenpapierhalter**

Spare toilet paper holder  
20×300×59 mm  
180012035

44,00 €



**WC-Bürstengarnitur, hängend**

Wall mounted toilet brush holder  
93×385×127 mm  
180013015\*

73,00 €



**WC-Bürstengarnitur, stehend/hängend**

Toilet brush holder free standing/wall mounted  
80×370×80 mm  
180913095\*

118,00 €



**Glasseifenschale**

Soap dish  
103×42×117 mm  
180008025

46,00 €



**Zahnglshalter**

Toothbrush holder  
64×100×97 mm  
180011015

46,00 €

\* schwarze Bürste/black brush



**Seifenspender**

Soap dispenser  
65×150×120 mm, 250 ml  
180009045

 54,00 €

**Wannengriff**

Grab bar  
320×40×60 mm  
180007075

 179,00 €

**Handtuchring**

Ring towel holder  
220×20×110 mm  
180004065

 62,00 €

180004045



180004055



**Handtuchhalter**

Towel holder  
297×20×59 mm  
180004045  
180004055

 44,00 €  
44,00 €

**Handtuchhalter**

Towel holder  
450×20×59 mm  
180004025  
600×20×59 mm  
180004035

 82,00 €  
91,00 €



**Doppelhandtuchhalter**

Double towel holder  
500×20×132 mm  
180004085

 145,00 €

**Handtuchhalter**

Towel holder  
500×20×205 mm  
180002185

 200,00 €



**Zweiarmiger Handtuchhalter, schwenkbar**

Double towel holder, swivel  
46×32×445 mm  
180004105

 136,00 €

**Glasablage**

Glass shelf  
500×19×118 mm  
180002355  
600×19×118 mm  
180002245

 46,00 €  
47,00 €

# organic/organic BLACK

Design by  
doc. MgA. René Šulc



material  
Material

Edelstahl  
stainless  
steel

Glas  
glass

Kunststoff  
plastic

Oberflächenfinish  
Surface finish

poliert  
polished

schwarz  
matt  
black matt



### Kleiderhaken

Single robe hook  
44×58×39 mm  
157106191  
167106190

20,00 €  
24,00 €



### Kleiderhaken

Single robe hook  
44×58×39 mm  
157106191L  
167106190L

20,00 €  
24,00 €



### Doppelkleiderhaken

Double robe hook  
68×58×39 mm  
157106211  
167106210

21,00 €  
26,00 €



### WC-Bürstengarnitur, hängend

Wall mounted toilet brush holder  
80×345×110 mm  
157113061\* 76,00 €  
167113060\* 84,00 €



### Asymmetrischer Kleiderhaken

Asymmetric robe hook  
68×78×39 mm  
157106201  
167106200

22,00 €  
26,00 €



### Asymmetrischer Kleiderhaken

Asymmetric robe hook  
68×78×39 mm  
157106201L  
167106200L

22,00 €  
26,00 €



### Toilettenpapierhalter

Toilet paper holder  
150×40×59 mm  
157112021  
167112020

45,00 €  
49,00 €



Glasbehälter  
glass container

### WC-Bürstengarnitur, hängend

Wall mounted toilet brush holder  
95×360×122 mm  
157113141\*\* 68,00 €  
167113140\* 74,00 €



### Reservetoilettenpapierhalter

Spare toilet paper holder  
38×165×59 mm  
157112031  
167112030

41,00 €  
43,00 €



### Toilettenpapierhalter mit Ablage

Toilet paper holder with shelf  
150×75×110 mm  
157112151  
167112150

52,00 €  
59,00 €



### Doppelt toilettenpapierhalter mit Ablage

Double toilet paper holder with shelf  
280×75×110 mm  
157112161  
167112160

93,00 €  
109,00 €



Glasbecher  
glass cup



Kunststoffbecher  
plastic cup



Glasbehälter  
glass container



Kunststoffbehälter  
plastic container

### Zahnglshalter

Toothbrush holder  
100×140×110 mm  
157111051  
167111050

56,00 €  
76,00 €

### Zahnglshalter

Toothbrush holder  
100×100×110 mm, 200 ml  
157111011  
167111010

56,00 €  
67,00 €

### Seifenspender

Soap dispenser  
100×115×110 mm, 200 ml  
157109461  
167109460

101,00 €  
108,00 €

### Seifenspender

Soap dispenser  
200×115×100 mm, 2×200 ml  
157109271  
167109270

170,00 €  
208,00 €

\* schwarze Bürste/black brush  
\*\* weiße Bürste/white brush



Glasbehälter  
glass container

### Seifenspender

Soap dispenser

100×190×110 mm, 300 ml

157109561

101,00 €  
108,00 €

Glasbehälter  
glass container



### Doppelseifenspender

Double soap dispenser

200×115×100 mm, 2×200 ml

157109471

170,00 €  
208,00 €

Kunststoffbehälter  
plastic container



### Doppelseifenspender

Soap dispenser

100×115×110 mm, 200 ml

157109261

87,00 €  
107,00 €



### Seifenspenderöffner

Soap dispenser key

80×9×75 mm

131567791

Part of the packaging of soap dispensers.  
Teil der Verpackung von Seifenspendern.



### Seifenschale

Soap dish

120×25×85 mm

157108331

38,00 €  
44,00 €



### Handtuchring

Ring towel holder

250×241×123 mm

157104391

148,00 €  
156,00 €



### Handtuchring

Ring towel holder

250×110×59 mm

157104381

78,00 €  
86,00 €



### Handtuchring

Ring towel holder

220×20×112 mm

157104061

54,00 €  
59,00 €



### Handtuchhalter

Towel holder

455×38×59 mm

157104351

74,00 €  
81,00 €



### Handtuchhalter

Towel holder

555×38×59 mm

157104361

82,00 €  
90,00 €



### Handtuchhalter

Towel holder

655×38×59 mm

157104371

91,00 €  
100,00 €



### Doppelhandtuchhalter

Double towel holder

640×20×124 mm

157104051

82,00 €  
112,00 €



### Doppelhandtuchhalter

Double towel holder

500×20×112 mm

157104401

109,00 €  
130,00 €



### Zweiarmiger Handtuchhalter, schwenkbar

Double towel holder, swivel

62×42×445 mm

157004101

96,00 €  
121,00 €



### Handtuchhalter

Towel holder

640×20×214 mm

157105081

146,00 €  
165,00 €



### Handtuchhalter

Towel holder with rail

640×95×214 mm

157105151

163,00 €  
194,00 €



### Metallablage

Metal shelf

300×22×110 mm

157102371

116,00 €  
121,00 €



### Metallablage

Metal shelf

600×22×110 mm

157102381

157,00 €  
174,00 €



### Glasablage

Glass shelf

600×40×116 mm

157102241

82,00 €  
82,00 €

# gALLa

material  
material

Messing  
brass

Edelstahl  
stainless  
steel

Polyresin  
schwarz  
Polyresin  
black

Oberflächenfinish  
Surface finish

PVD

poliert  
polished  
matt  
matt



## Kleiderhaken

Single robe hook

20×60×46 mm

108106020

30,00 €

## Toilettenpapierhalter

Toilet paper holder

155×30×60 mm

108112030

50,00 €



## Seifenschale

Soap dish

107×34×115 mm

108108020

61,00 €

## Zahnglshalter

Toothbrush holder

75×123×99 mm

108110010

61,00 €

## Doppelzahnbürstenhalter

Double toothbrush holder

170×123×79 mm

108110020

90,00 €

## WC-Bürstengarnitur, hängend

Wall mounted toilet brush holder

105×360×119 mm

108113010\*

109,00 €



## Seifenspender

Soap dispenser

75×170×99 mm, 230 ml

108109010

102,00 €

## Handtuchring

Ring towel holder

230×100×60 mm

108104060

61,00 €

## Handtuchhalter

Towel holder

600×20×60 mm

108104040

93,00 €



## Doppelhandtuchhalter

Double towel holder

600×20×104 mm

108104050

136,00 €

## Handtuchhalter

Towel holder

600×20×200 mm

108105080

219,00 €

\* schwarze Bürste/black brush

# Omega



**SET OMEGA, 6 St.**  
SET OMEGA, 6 pcs  
204601

160,00 €

**Kleiderhaken**  
Single robe hook  
55×55×50mm  
104106022

19,00 €

**Doppelkleiderhaken**  
Double robe hook  
55×55×50mm  
104106032

22,00 €

**Kleiderhaken**  
Single robe hook  
55×55×70mm  
104206022

24,00 €



**Doppelkleiderhaken**  
Double robe hook  
84×60×66mm  
104206032

27,00 €

**Kleiderhaken**  
Single robe hook  
55×55×55mm  
104106062

17,00 €

**Kleiderhaken**  
Single robe hook  
25×25×38mm  
104206132

9,00 €

**Kleiderhaken zum Kleben**  
Single robe hook, self-adhesive  
51×51×41mm  
104206272

11,00 €



**Kleiderhaken zum Kleben**  
Single robe hook, self-adhesive  
51×51×42mm  
104206262

12,00 €

**Kleiderhaken**  
Single robe hook  
ø 16×30mm  
104506092  
ø 16×55mm  
104506082

8,00 €

9,00 €

**Kleiderhaken, Paar**  
Single robe hook, pair  
ø 16×30mm  
104506292

13,00 €

**Kleiderhaken**  
Single robe hook, for bag  
ø 15×35mm  
104206023  
ø 25×50mm  
104206024

7,00 €

9,00 €



**Kleiderhaken, Paar**  
Single robe hook, pair  
ø 16×55mm  
104506282

17,00 €

**Kleiderhaken**  
Cloth hook  
55×110×60mm  
104105242

31,00 €

**Kleiderhaken**  
Cloth hook  
55×115×60mm  
104105252

35,00 €

**Toilettenpapierhalter**  
Toilet paper holder  
140×95×90mm  
104112042  
104112042R

35,00 €

35,00 €



**Toilettenpapierhalter mit Deckel**  
Toilet paper holder with cover  
140×155×80mm  
104112012  
104112012R

52,00 €

52,00 €

**Toilettenpapierhalter mit Deckel**  
Toilet paper holder with cover  
135×170×90mm  
104212012

57,00 €

**Toilettenpapierhalter**  
Toilet paper holder  
180×55×70mm  
104212032  
104212032L

41,00 €

41,00 €

**Toilettenpapierhalter, doppelt**  
Double paper holder  
385×55×85mm  
104201072

69,00 €

material

Messing

Glas

Oberflächenfinish

Surface finish

Chrom

chrome

poliert

polished



**Doppel-Toilettenpapierhalter mit Deckel**  
Double paper holder with cover  
270×140×107 mm  
104112092 **103,00 €**



**Toilettenpapierhalter**  
Toilet paper holder  
132×105×27 mm  
104212192 **59,00 €**



**Toilettenpapierhalter**  
Toilet paper holder  
150×105×67 mm  
199112042 **47,00 €**



**Reservepapierrollenhalter**  
Spare toilet paper holder  
55×165×65 mm  
104112032 **33,00 €**



**Reservepapierrollenhalter**  
Spare toilet paper holder, extended  
55×315×65 mm  
104112142 **43,00 €**



**WC-Bürstengarnitur, hängend**  
Wall mounted toilet brush holder  
95×385×120 mm  
104913112\* **68,00 €**  
104913117\*\* **68,00 €**



**Free standing toilet paper and brush holder**  
Free standing toilet paper  
250×730×250 mm  
104836012 **237,00 €**



**Free standing toilet paper and brush holder**  
Free standing toilet paper  
250×730×250 mm  
104836112 **282,00 €**



**WC-Bürstengarnitur, hängend**  
Wall mounted toilet brush holder  
90×365×100 mm  
104913122 **59,00 €**



**WC-Bürstengarnitur, stehend**  
Toilet brush holder  
90×385×90 mm  
104913092 **62,00 €**



**WC-Bürstengarnitur, stehend**  
Toilet brush holder  
90×365×90 mm  
104913152 **48,00 €**



**WC-Bürstengarnitur, stehend**  
Toilet brush holder, for standing  
110×400×130 mm  
104113102\* **44,00 €**  
104113107\*\* **44,00 €**



**WC-Bürstengarnitur, hängend**  
Wall mounted toilet brush holder  
95×370×140 mm  
104113012\* **56,00 €**  
104113017\*\* **56,00 €**



**WC-Bürstengarnitur, stehend/hängend**  
Toilet brush holder, free standing/wall mounted  
95×385×105 mm  
102313066\* **79,00 €**  
102313067\*\* **79,00 €**



**WC-Bürstengarnitur, stehend**  
Toilet brush holder, free standing  
95×380×95 mm  
102313056\* **79,00 €**  
102313057\*\* **79,00 €**



**Seifenspender**  
Soap dispenser, glass  
85×114×100 mm, 200 ml  
104309322 **92,00 €**



**Seifenspender**  
Soap dispenser  
75×145×100 mm, 200 ml  
104109102 **87,00 €**



**Seifenspender**  
Soap dispenser  
80×190×133 mm, 230 ml  
104109017 **76,00 €**



**Seifenspender**  
Soap dispenser  
55×175×85 mm, 150 ml  
104109012 **76,00 €**



**Seifenspender**  
Soap dispenser  
55×195×85 mm, 150 ml  
104609172 **79,00 €**

\*weiße Bürste/white brush  
\*\*black brush/black brush



**Seifenspender**

Soap dispenser  
70×230×110 mm, 550 ml  
104109032 **156,00 €**



**Seifenspender mit Magnetseifenhalter**

Soap dispenser with magnetic soap holder, glass  
75×160×100 mm, 200 ml  
104109182 **102,00 €**



**Seifenspender**

Soap dispenser, glass  
75×150×100 mm, 200 ml  
138709041 **62,00 €**



**Glasseifenschale**

Soap dish  
110×55×129 mm  
104108042 **41,00 €**



**Metall-Seifenhalter**

Soap dish metallic  
125×55×115 mm  
104208082 **34,00 €**



**Seifenhalter**

Soap dish  
140×55×125 mm  
104108162 **38,00 €**



**Magnetseifenhalter**

Magnetic soap holder  
55×55×70 mm  
104108202 **36,00 €**



**Zahnglshalter**

Toothbrush holder  
70×95×105 mm  
104110012 **38,00 €**



**Doppel-Zahnglshalter**

Double Toothbrush holder  
160×95×90 mm  
104110022 **58,00 €**



**Doppel-Zahnglshalter**

Double Toothbrush holder  
190×95×125 mm  
104110042 **76,00 €**



**Zahnglshalter**

Toothbrush holder  
105×55×85 mm  
104110032 **33,00 €**



**Seifenspender, stehend**

Soap dispenser, free standing  
80×160×80 mm, 200 ml  
138109161 **62,00 €**



**Zahnglshalter, stehend**

Glass holder with glass, free standing  
80×100×80 mm  
138110061 **36,00 €**



**Glasseifenschale stehend**

Soap dish holder, free standing  
110×60×110 mm  
138108191 **35,00 €**



**Glasseifenschale, stehend**

Soap dish, free standing  
98×15×98 mm  
139108342 **69,00 €**



**Doppelhaken**

Double hook  
55×120×90 mm  
104405222 **47,00 €**



**Dreifachhaken, drehbar**

Triple hook  
55×190×135 mm  
104206072 **55,00 €**



**Dreifachhaken, drehbar**

Triple hook  
55×85×95 mm  
104106072 **49,00 €**



**Hakenleiste mit 4 Haken**

Rail with 4 robe hooks  
270×25×40 mm  
104606102 **39,00 €**



**Hakenleiste mit 6 Haken**

Rail with 6 robe hooks  
410×25×40 mm  
104606112 **54,00 €**



**Doppelhaken**

Double hook  
120×55×50 mm  
104405202



37,00 €



**Dreifachhaken**

Triple hook  
185×55×50 mm  
104405232



55,00 €



**Vierfachhaken**

4 robe hooks  
250×55×50 mm  
104405212



76,00 €

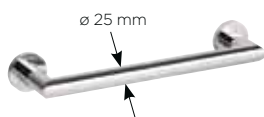

**Handtuchhalter**

Towel holder  
354×54×65 mm  
104204332  
653×54×65 mm  
104204342



61,00 €

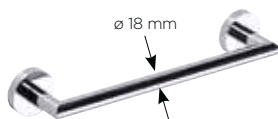

**Handtuchhalter**

Towel holder  
355×55×65 mm  
104204012  
505×55×65 mm  
104204022  
655×55×65 mm  
104204042  
855×55×65 mm  
104204262



48,00 €



**Doppelhandtuchhalter**

Double towel holder  
655×55×120 mm  
104204052  
855×55×120 mm  
104204272



81,00 €

76,00 €

74,00 €

116,00 €



**Handtuchhalter**

Towel holder  
655×55×215 mm  
104205082



109,00 €



**Handtuchhalter, klappbar**

Tiltable Towel holder  
655×55×270 mm  
104205152



153,00 €



**Handtuchhalter**

Towel holder with rail  
655×110×215 mm  
104205072  
550×120×265 mm  
104219072



147,00 €

144,00 €



**Handtuchhalter, klappbar mit Haken**

Tiltable towel holder with hooks  
655×105×270 mm  
104205162



171,00 €



**Doppelhandtuchhalter**

Double towel holder with rail  
655×160×225 mm  
104205102



177,00 €



**Handtuchhalter, U-Form**

Double towel holder with rail  
655×155×270 mm  
104205172



184,00 €



**Handtuchring**

Ring towel holder  
160×175×65 mm  
104204062



40,00 €



**Zweiarmiger Handtuchhalter, schwenkbar**

Double towel holder, swivel  
55×55×420 mm  
104204191



69,00 €



**Dreistufiger Handtuchstander**

Free standing three swing arm towel stand  
370×850×250 mm  
104836032

253,00 €



**Zweiarmer Handtuchhalter, schwenkbar**

Double towel holder, swivel  
55×165×450 mm  
104204102



61,00 €



**Dreiarmer Handtuchhalter, schwenkbar**

Triple towel holder, swivel  
55×195×450 mm  
104204112



82,00 €



**Hakenleiste mit 5 Haken**

Hanger with 5 hooks  
320×55×70 mm  
146105112



82,00 €



**Küchenrollenhalter mit Seifenspender**

Towel holder with soap dispenser  
455×180×115 mm, 230 ml  
104019012



115,00 €



**Doppelhandtuchhalter**

Double towel holder  
50×90×365 mm  
104704142



45,00 €



**Handtuchhalter für Glastür**

Towel holder for glass door  
520×20×133 mm  
104204352



94,00 €

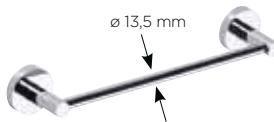

**Handtuchhalter**

Towel holder  
355×55×65 mm  
104104012  
505×55×65 mm  
104104022  
655×55×65 mm  
104104042



38,00 €



**Doppelhandtuchhalter**

Double towel holder  
655×55×110 mm  
104104052



61,00 €

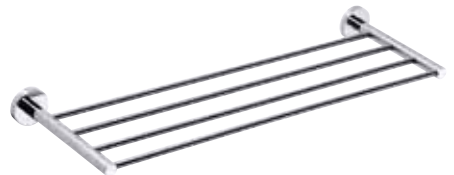

**Handtuchhalter**

Towel holder  
655×55×200 mm  
104105082



89,00 €

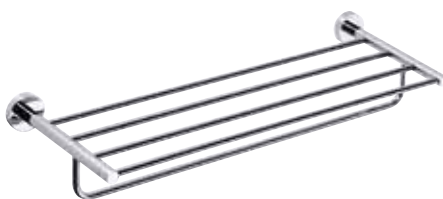

**Handtuchhalter**

Towel holder with rail  
655×110×200 mm  
104105072



103,00 €



**Handtuchring**

Ring towel holder  
160×190×55 mm  
104104062



35,00 €



**Hakenleiste mit 5 Haken**

Rail with 5 robe hooks  
415×55×70 mm  
104105112



54,00 €



**Küchenrollenhalter**

Kitchen roll holder  
295×100×62 mm  
146403152



48,00 €



**Duschablage**

Metal shelf  
270×40×110 mm  
146102272



93,00 €



**Glasablage**

Glass shelf  
300×55×130 mm  
104122042



47,00 €



**Glasablage**

Glass shelf  
600×55×130 mm  
104102042



51,00 €

**Glasablage**

Glass shelf  
600×65×130 mm  
104202042



62,00 €

**Glasablage**

Glass shelf with tiltable rail  
300×55×130 mm  
104102202



75,00 €

**Glasablage**

Glass shelf with hinged rail  
600×55×130 mm  
104102212



93,00 €



**Glasablage, Eckmodell**

Glass shelf corner model  
325×55×255 mm  
104102012



53,00 €

**Glasablage, Eckmodell**

Glass shelf with rail corner model  
325×60×255 mm  
104202162



68,00 €

**Zweistufige Glasablage**

Double glass shelf with rail  
400×380×120 mm  
104202122



149,00 €



**Dreistufige Glasablage, Eckmodell**

Double corner glass shelf with rail  
355×380×270 mm  
104202142



142,00 €

**Dreistufige Glasablage**

Triple glass shelf with rail  
400×665×130 mm  
104202132



189,00 €

**Dreistufige Glasablage, Eckmodell**

Triple corner glass shelf with rail  
355×660×270 mm  
104202152



184,00 €



**Wannengriff**

Grab bar  
355×55×75 mm  
102307012  
500×55×75 mm  
102307052



55,00 €

**Winkelgriff 135°**

Grab bar angled, 135°  
425×215×80 mm  
102307022



107,00 €

**Winkelgriff 135° mit Seifenkorb**

Grab bar angled with soap dish, 135°  
400×200×130 mm  
102307032



102,00 €



**Wannengriff**

Grab bar  
350×50×75 mm  
104307611



71,00 €

**Winkelgriff 135°**

Grab bar angled, 135°  
412×203×74 mm  
104307621



89,00 €

**Winkelgriff 135° mit Seifenkorb**

Grab bar angled with soap dish, 135°  
440×220×130 mm  
104307631



117,00 €



**Wannengriff mit schwarzem Gummi**

Grab bar, rubber  
355x50x80 mm  
104507661



55,00 €

**Wannengriff mit schwarzem Gummi**

Grab bar, rubber  
455x50x85 mm  
104507675



60,00 €

**Wannengriff mit schwarzem Gummi**

Grab bar, rubber  
655x50x80 mm  
104507681



72,00 €



**Wannengriff mit schwarzem Gummi**

● Grab bar, rubber  
855x50x80 mm  
104507691



15,00 €

**Wannengriff abgewinkelt 135° mit schwarzem Gummi**

135° grab bar, black rubber  
640x292x85 mm  
104507711  
104507701



110,00 €

**Wattepad-Spender**

Container for cosmetic pads  
65x205x115 mm  
146503172



48,00 €

! Bis zum Ausverkauf.  
● Till sold out.

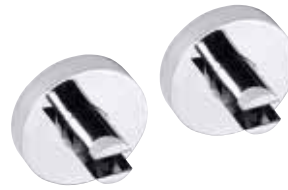

**Spiral Fönhalter**

Hairdryer holder, spiral  
100x130x125 mm  
104117022



41,00 €

**Fönhalter**

Hairdryer holder  
80x55x100 mm  
101117012



37,00 €

**Halterung für Glasablagen ohne Glas, Paar**

Glass shelf holder without glass, pair  
55x55x40 mm  
104102112-6mm ≠ 6 mm 41,00 €  
104102112-8mm ≠ 8 mm 41,00 €



**Halterung für Glasablagen ohne Glas, Paar**

Glass shelf holder without glass, pair  
19x19x28 mm  
104502112-6mm ≠ 6 mm 31,00 €  
104502112-8mm ≠ 8 mm 31,00 €



**Duschabzieher**

Glass door squeegee  
265x175x55 mm  
104237012



60,00 €

**Türhaken**

Hook for door  
20x70x40 mm  
104106152

41,00 €

**Halter für Kippspiegel**

Holders for tilting mirror (2 pcs.)  
55x78x90 mm, ≠ 6 mm  
301501131



60,00 €

**Abdeckplatte zum Kleben auf Glas\***

Back plate for gluing accessories\*  
55x55x14 mm  
131567152



40,00 €

\*\*\* Kleber ist nicht in der Packung enthalten  
Glue is not included.

# Neo

material  
material

Edelstahl  
stainless steel

Glas  
glass

Oberflächenfinish  
Surface finish

matt  
matt



**Kleiderhaken**  
Single robe hook  
55×55×55 mm  
104106065

   
18,00 €



**Kleiderhaken**  
Single robe hook  
55×55×50 mm  
104106025

   
20,00 €



**Doppelkleiderhaken**  
Double robe hook  
55×55×50 mm  
104106035

   
21,00 €



**Kleiderhaken**

Single robe hook  
ø 16×30 mm  
104506095  
ø 16×55 mm  
104106165

  
9,00 €  
11,00 €



**Dreifachhaken, drehbar**  
Hanger with 3 hooks, swivel  
55×190×130 mm  
104206075

   
69,00 €



**Toilettenpapierhalter mit Deckel**  
Toilet paper holder with cover  
137×143×90 mm  
104112015

   
54,00 €



**Toilettenpapierhalter**  
Toilet paper holder  
135×120×98 mm  
104112045  
104112045R

   
36,00 €  
36,00 €



**Toilettenpapierhalter**  
Toilet paper holder  
175×55×70 mm  
104212035  
104212035L

  
41,00 €  
41,00 €



**Toilettenpapierhalter**  
Toilet paper holder  
132×105×27 mm  
104212195

   
52,00 €

**Reservepapierrollenhalter**  
Spare toilet paper holder  
55×165×65 mm  
104112035

   
34,00 €

**Freistehender Toilettenpapierhalter**  
Spare toilet paper holder free standing  
120×354×120 mm  
146203165

44,00 €

**Toilettenpapierhalter, doppelt**  
Double paper holder  
320×30×90 mm  
146212245

  
80,00 €



**WC-Bürstengarnitur, hängend**  
Wall mounted toilet brush holder  
110×350×140 mm  
104113015\*  
104113019\*\*

   
54,00 €  
54,00 €



**WC-Bürstengarnitur, stehend**  
Toilet brush holder, free standing  
110×400×130 mm  
104113105\*  
104113109\*\*

48,00 €  
48,00 €

**WC-Bürstengarnitur, hängend**  
Wall mounted toilet brush holder  
90×380×115 mm  
102313075\*  
102313079\*\*

   
96,00 €  
96,00 €

**WC-Bürstengarnitur, stehend**  
Toilet brush holder, free standing  
95×380×95 mm  
102313055\*  
102313059\*\*

79,00 €  
79,00 €

**WC-Bürstengarnitur, stehend/hängend**  
Toilet brush holder, free standing/wall mounted  
95×380×105 mm  
102313065\*  
102313069\*\*

  
109,00 €  
109,00 €

\*weiße Bürste/white brush  
\*\*black brush/black brush

**Handtuchring**

Ring towel holder  
160×190×50 mm  
104104065



38,00 €

**Seifenspender**

Soap dispenser, glass  
75×145×100 mm, 200 ml  
104109115



54,00 €

**Seifenspender**

Soap dispenser  
80×190×133 mm, 230 ml  
104109016



76,00 €

**Seifenspender**

Soap dispenser  
55×175×85 mm, 150 ml  
104109015



91,00 €

**Seifenspender JUMBO**

Soap dispenser JUMBO  
70×230×110 mm, 550 ml  
104109035



151,00 €

**Glasseifenschale**

Soap dish holder  
110×55×129 mm  
104108045



34,00 €

**Metall-Seifenhalter**

Soap dish metallic  
125×55×115 mm  
104208085



32,00 €

**Zahnglshalter**

Holder with glass  
70×95×105 mm  
104110015



34,00 €

**Doppel-Zahnglshalter**

Double glass holder  
175×118×90 mm  
104210025



62,00 €

**Seifenkorb**

Soap basket  
230×30×120 mm  
104308072



45,00 €

**Eckduschkorb**

Corner soap basket  
230×30×130 mm  
104308172



43,00 €

**Duschablage**

Soap dish polished surface  
270×40×110 mm  
146102275



93,00 €

**Zweiarmiger Handtuchhalter, schwenkbar**

Double towel holder, swivel  
55×165×445 mm  
104204105



69,00 €

**Handtuchhalter**

Towel holder with rail  
655×110×215 mm  
104205075

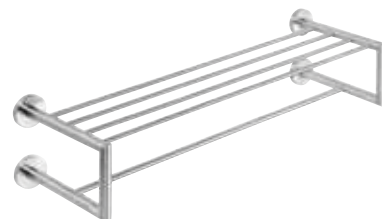

151,00 €

**DoppelHandtuchhalter**

Double Towel holder with rail  
655×160×225 mm  
104205105



182,00 €



**Handtuchhalter**

Towel holder  
355×55×65 mm  
104204015



505×55×65 mm  
104204125  
655×55×65 mm  
104204045

54,00 €  
68,00 €

**Doppelhandtuchhalter**

Double towel holder  
655×55×125 mm  
104204055

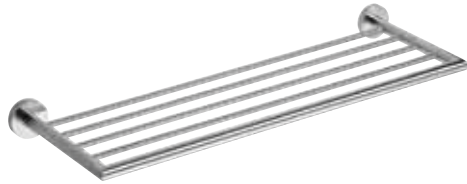

**Handtuchhalter**

Towel holder  
655×55×215 mm  
104205085



**Wannengriff**

Bath grab bar  
355×55×75 mm  
102307015



**Türhaken**

Robe hook  
20×70×40 mm  
104106153

39,00 €



**Türhaken**

Over door hook  
25×85×34 mm  
101106155

17,00 €

**Türhakenleiste mit 3 Haken**

Hanger with 3 hooks for door  
175×85×34 mm  
101106225

21,00 €

**Türhakenleiste mit 6 Haken**

Hanger with 6 hooks for door  
350×85×34 mm  
101106235

26,00 €



**Hakenleiste mit 4 Haken**

Rail with 4 robe hooks  
270×28×40 mm  
104606105



**Hakenleiste mit 6 Haken**

Rail with 6 robe hooks  
410×28×40 mm  
104606115



**Glasablage**

Glass shelf  
600×55×130 mm  
104102045



**Glasablage Eckmodell**

Glass shelf, corner model  
244×55×244 mm  
104102015

63,00 €

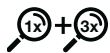

**Kosmetikspiegel**

Cosmetic mirror  
180×250×360 mm, ø 140 mm  
106301705



**Hygienebeutelspender (HygBag)**

Hygiene bags dispenser (HygBag)  
100×140×25 mm  
101403035



**Kosmetiktuchbox**

Paper tissue dispenser  
250×130×75 mm  
102303025

54,00 €

# coral/amber

158XXXXXX

155XXXXXX

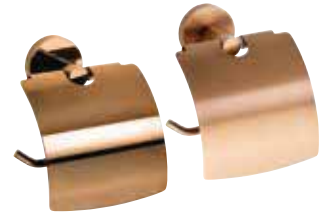

## Kleiderhaken

Single robe hook

55×55×50 mm

158106022

155106022



40,00 €

40,00 €

## Doppelkleiderhaken

Double robe hook

55×55×50 mm

158106032

155106032



40,00 €

40,00 €

## Kleiderhaken

Single robe hook

16×16×30 mm

158506092

155506092



10,00 €

10,00 €

## Toilettenpapierhalter mit Deckel

Toilet paper holder with cover

140×155×80 mm

158112012

155112012



105,00 €

105,00 €

material  
material

Messing  
brass

Glas  
glass

Oberflächenfinish  
Surface finish

PVD

poliert  
polished

matt  
matt



## Toilettenpapierhalter

Toilet paper holder

55×165×65 mm

158212032

155212032



59,00 €

73,00 €

## Reservepapierrollenhalter

Spare toilet paper holder

55×165×65 mm

158112032

155112032



64,00 €

64,00 €

## WC-Bürstengarnitur, hängend

Wall mounted toilet brush holder

95×360×140 mm

158113017\*

155113017\*



101,00 €

101,00 €

## WC-Bürstengarnitur, stehend/hängend

Toilet brush holder free standing/wall mounted

95×380×105 mm

158313067\*

155313067\*



169,00 €

169,00 €

## Glasseifenschale

Soap dish

110×55×129 mm

158108042

155108042



71,00 €

72,00 €

## Zahnglshalter

Toothbrush holder

70×95×105 mm

158110012

155110012



71,00 €

72,00 €



## Seifenspender

Soap dispenser

75×145×100 mm, 200 ml

158109102

155109102



109,00 €

116,00 €

## Handtuchhalter

Towel holder

505×55×65 mm

158204022

155204022



96,00 €

96,00 €

## Handtuchhalter

Towel holder

655×55×65 mm

158204042

155204042



113,00 €

113,00 €



## Eckduschablage

Corner shower shelf

265×90×205 mm

158208312

155208312



102,00 €

115,00 €

## Abfalleimer

Waste bin

205×265×260 mm, 5 l

158315010

155315010

114,00 €

114,00 €

Der Farbton des Abfalleimers kann von der Abbildung auf dem Foto abweichen. The color shade of the trashbasket may differ from the image in the photo.

# BRILLO/SABLO

161XXXXXX

160XXXXXX

material  
material

Messing  
brass

Glas  
glass

Oberflächenfinish  
Surface finish

PVD

poliert  
polished

matt  
matt

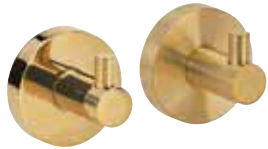

### Kleiderhaken

Single robe hook  
55×55×50 mm

161106020  
160106020

35,00 €  
35,00 €



### Doppelkleiderhaken

Double robe hook  
55×55×50 mm

161106032  
160106032

36,00 €  
36,00 €



### Kleiderhaken

Single robe hook  
55×55×55 mm

160106060

26,00 €



### Kleiderhaken

Single robe hook  
16×16×30 mm

161506090  
160506090

10,00 €  
10,00 €

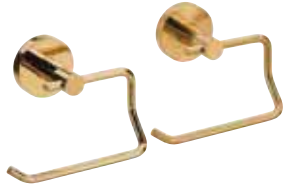

### Toilettenpapierhalter

Toilet paper holder  
140×95×90 mm

161112042  
160112042

66,00 €  
73,00 €

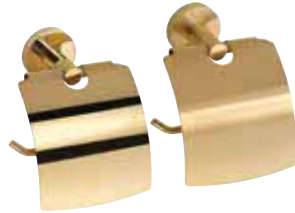

### Toilettenpapierhalter mit Deckel

Toilet paper holder with cover  
140×155×80 mm

161112010  
160112010

91,00 €  
89,00 €



### Toilettenpapierhalter

Toilet paper holder  
175×55×70 mm

161212030  
160212030

73,00 €  
73,00 €



### Toilettenpapierhalter

Toilet paper holder  
175×55×70 mm

161212030L  
160212030L

73,00 €  
73,00 €



### Reservepapierrollenhalter

Spare toilet paper holder  
55×165×65 mm

161112030  
160112030

54,00 €  
56,00 €



### WC-Bürstengarnitur, hängend

Wall mounted toilet brush holder  
95×370×140 mm

161113017\*  
160113017\*

102,00 €  
88,00 €



### WC-Bürstengarnitur, stehend/hängend

Toilet brush holder  
free standing/wall mounted  
95×380×105 mm

161313060\*  
160313060\*

145,00 €  
149,00 €



### Glasseifenschale

Soap dish  
110×55×129 mm

161108042  
160108042

66,00 €  
73,00 €



### Zahnglashalter

Toothbrush holder  
70×95×105 mm

161110012  
160110012

66,00 €  
66,00 €



### Seifenspender

Soap dispenser  
75×145×100 mm

161109102  
160109102

98,00 €  
97,00 €



### Wannengriff

Bath grab bar  
350×50×75 mm

161307611  
160307611

110,00 €  
100,00 €



### Eckduschablage

Corner shower shelf  
250×60×155 mm

161208340  
160208340

132,00 €  
140,00 €



### Handtuchhalter

Towel holder  
505×55×65 mm

161204020  
160204020

88,00 €  
84,00 €



### Doppelter Handtuchhalter

Towel holder  
655×55×120 mm

161204052  
160204052

139,00 €  
149,00 €



### Zweiarmer Handtuchhalter, schwenkbar

Double towel holder, swivel  
55×55×420 mm

161204190  
160204190

100,00 €  
108,00 €



### Abfallimer

Waste bin  
205×265×260 mm, 5 l

161315010  
160315010

114,00 €  
114,00 €

# HEMATIT/graphit

159XXXXXX

156XXXXXX



**Kleiderhaken**  
Single robe hook

55×55×50 mm  
159106022  
156106022

42,00 €  
42,00 €

**Doppelkleiderhaken**  
Double robe hook

55×55×50 mm  
159106032  
156106032

43,00 €  
43,00 €

**Toilettenpapierhalter**

Toilet paper holder  
140×95×90 mm  
156112042

73,00 €  
73,00 €

**Toilettenpapierhalter mit Deckel**

Toilet paper holder with cover  
140×155×80 mm  
159112012  
156112012

113,00 €  
111,00 €

material

Messing

Glas

Oberflächenfinish

Surface finish

PVD

poliert

polished

matt

matt

**Kleiderhaken**

Single robe hook  
16×16×30 mm  
156506092

10,00 €



**Toilettenpapierhalter**

Toilet paper holder  
175×55×70 mm  
159212032  
156212032

73,00 €  
73,00 €

**Reservepapierrollenhalter**

Spare toilet paper holder  
55×165×65 mm  
159112032  
156112032

69,00 €  
70,00 €



**WC-Bürstengarnitur, hängend**

Wall mounted toilet brush holder  
95×360×140 mm  
159113017\*  
156113017\*

112,00 €  
112,00 €



**WC-Bürstengarnitur, stehend/hängend**

Toilet brush holder  
free standing/wall mounted  
95×342×105 mm  
159313067\*  
156313067\*

191,00 €  
191,00 €

**Glasseifenschale**

Glass soap dish  
110×55×129 mm  
159108042  
156108042

79,00 €  
79,00 €



**Zahnglashalter**

Holder with glass  
70×95×105 mm  
159110012  
156110012

79,00 €  
79,00 €



**Seifenspender**

Soap dispenser, glass  
75×145×100 mm, 200 ml  
159109102  
156109102

109,00 €  
116,00 €



**Handtuchhalter**

Towel holder  
505×55×65 mm  
159204022  
159204022

107,00 €  
107,00 €

**Handtuchhalter**

Towel holder  
655×55×65 mm  
159204042  
156204042

124,00 €  
124,00 €



**Duschablage**

Soap dish polished surface  
270×40×110 mm  
156102272

136,00 €



**Eckduschkorb**

Soap basket  
265×90×205 mm  
159208312  
156208312

102,00 €  
115,00 €

**Abfalleimer "Soft Close"**

Waste bin "Soft Close"  
205×265×260 mm, 5 l  
159315013  
156315013

114,00 €  
114,00 €



Der Farbton des Abfalleimers kann von der Abbildung auf dem Foto abweichen. The color shade of the trashbasket may differ from the image in the photo.

\* schwarze Bürste/black brush

# white/dark

XXXXXXXXX4

XXXXXXXXX0



material  
material

## Kleiderhaken

Single robe hook  
55×55×50mm

104106024  
104106020

22,00 €  
25,00 €

## Doppelkleiderhaken

Double robe hook  
55×55×50mm

104106034  
104106030

24,00 €  
27,00 €

## Kleiderhaken Single robe hook

55×55×65mm  
104206020

32,00 €

## SET WHITE/DARK, 6 St.

SET WHITE/DARK, 6 pcs

204604  
204600

163,00 €  
163,00 €

Messing  
brass

Glas  
glass

Oberflächenfinish  
Surface finish

weiße  
Lack  
White  
lacquer

schwarz  
Lack  
black  
lacquer

matt  
matt



## Kleiderhaken Single robe hook

55×55×65mm  
104106060

22,00 €

## Kleiderhaken

Single robe hook  
16×16×30mm

104506094  
104506090

6,00 €  
6,00 €

## Kleiderhaken

Single robe hook  
16×16×55mm

104506084  
104506080

12,00 €  
12,00 €

## Doppelhaken

Double hook  
120×55×50mm

104405200

34,00 €



## Türhaken

Hook for door  
25×85×34mm

101106154  
101106150

11,00 €  
11,00 €

## Türhakenleiste mit 4 Haken

Hanger with 3 hooks for door  
175×85×34mm

101106224  
101106220

16,00 €  
16,00 €

## Türhakenleiste mit 6 Haken

Hanger with 6 hooks for door  
350×87×34mm

101106234  
101106230

22,00 €  
22,00 €



## Dreifach-Haken, drehbar

Swing arm triple hook  
55×190×135mm

104206070

55,00 €

## Hakenleiste mit 4 Haken

Rail with 4 robe hooks  
270×25×40mm

104606100

52,00 €

## Toilettenpapierhalter

Toilet paper holder  
140×95×90mm

104112044  
104112040

36,00 €  
37,00 €

## Toilettenpapierhalter mit Deckel

Toilet paper holder with cover  
140×155×80mm

104112014  
104112010

56,00 €  
65,00 €



## Toilettenpapierhalter

Toilet paper holder  
175×55×70mm

104212034  
104212030

42,00 €  
50,00 €

## Toilettenpapierhalter

Toilet paper holder  
175×55×70mm

104212034L  
104212030L

42,00 €  
50,00 €

## Reservepapierrollenhalter

Spare toilet paper holder  
55×165×65mm

104112034  
104112030

39,00 €  
42,00 €

## Toilettenpapierhalter, doppelt

Double paper holder  
385×55×85mm

104201070

71,00 €



**WC-Bürstengarnitur, hängend**

Toilet brush holder, white brush

95×370×140 mm

104113014



65,00 €



**WC-Bürstengarnitur, hängend**

Toilet brush holder

95×370×140 mm

104113010



65,00 €



**WC-Bürstengarnitur, stehend**

Wall mounted toilet brush

90×385×90 mm

104913094

65,00 €



**WC-Bürstengarnitur, stehend**

Wall mounted toilet brush

90×380×90 mm

104913090

68,00 €



**WC-Bürstengarnitur, hängend**

Wall mounted toilet brush holder

90×365×100 mm

104913124

104913120



71,00 €

71,00 €



**WC-Bürstengarnitur, stehend/hängend**

Toilet brush holder, free standing/wall mounted

90×380×90 mm

102313064

102313060



102,00 €

122,00 €



**WC-Bürstengarnitur, stehend/hängend**

Toilet brush holder, free standing/wall mounted

80×400×80 mm

102913094

137,00 €



**Freistehende WC-Bürstengarnitur**

Free standing toilet paper and brush holder

250×730×250 mm

104836110

312,00 €



**Zahnglashalter**

Holder with glass

70×95×105 mm

104110014

104110010



43,00 €

51,00 €



**Zahnglashalter**

Toothbrush holder

105×54×89 mm

104110030



39,00 €



**Glasseifenschale**

Soap dish holder

110×55×129 mm

104108044

104108040



43,00 €

51,00 €



**Seifenthalter**

Soap dish

140×55×125 mm

104108160



51,00 €



**Seifenspender**

Soap dispenser, glass

75×145×100 mm, 200 ml

104109104

104109100



75,00 €

78,00 €



**Seifenspender**

Soap dispenser, glass

80×180×105 mm, 230 ml

104109014



72,00 €



**Seifenspender**

Soap dispenser, glass

80×190×133 mm, 230 ml

104109010



79,00 €



**Seifenspender**

Soap dispenser, glass

85×114×100 mm, 200 ml

104309320



95,00 €

\* schwarze Bürste/black brush

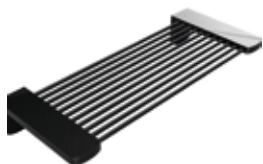

**Duschablage**

Soap dish  
270×40×110 mm  
146102270



100,00 €



**Eckseifenablage**

Corner soap basket  
262×35×142 mm  
102308264



57,00 €



**Eckseifenablage**

Corner soap basket  
262×35×142 mm  
102308260



57,00 €



**Eckduschablage**

Corner shower shelf  
290×47×220 mm  
153102390



58,00 €



**Duschablage**

Shower shelf  
300×26×115 mm  
102308080



78,00 €



**Eckduschkorb**

Corner shower shelf  
245×60×150 mm  
102308120



59,00 €



**Duschablage**

Shower shelf  
230×30×100 mm  
102308070



63,00 €



**Handtuchhalter**

Towel holder  
355×55×65 mm  
104204010



64,00 €



**Handtuchhalter**

Towel holder  
505×55×65 mm  
104204024  
104204020



64,00 €  
65,00 €



**Handtuchhalter**

Towel holder  
655×55×65 mm  
104204044  
104204020



68,00 €  
65,00 €



**Doppelter Handtuchhalter**

Double towel holder  
655×55×120 mm  
104204050



106,00 €



**Zweiarmiger Handtuchhalter, schwenkbar**

Double towel holder, swivel  
55×55×420 mm  
104204194



76,00 €



**Zweiarmiger Handtuchhalter, schwenkbar**

Double towel holder, swivel  
55×40×420 mm  
104204190



76,00 €



**Handtuchhalter**

Towel holder with rail  
550×120×265 mm  
104219074



177,00 €



**Handtuchhalter**

Towel holder with rail  
550×120×265 mm  
104219070



181,00 €



**Glasablage**

Glass shelf  
600x55x130 mm  
104102044



68,00 €

**Glasablage**

Glass shelf  
600x55x130 mm  
104102040



68,00 €

**Wannengriff**

Bath grab bar  
470x65x90 mm  
104307770



89,00 €



**Handtuchring**

Ring towel holder  
160x175x65 mm  
104204060



50,00 €

**Handtuchring**

Ring towel holder  
170x195x55 mm  
104104064  
104104060



41,00 €

40,00 €

**Handtuchhalter für Glastür**

Towel holder for glass door  
470x20x133 mm  
104204310



94,00 €



**Kosmetikspiegel mit 3x LED Beleuchtung**

Cosmetic mirror with 3x LED lighting  
255x200x400 mm, ø 200 mm  
112101144  
112101140



296,00 €

296,00 €

**Kosmetikspiegel mit 2x LED Beleuchtung**

Cosmetic mirror with 2x LED light  
225x200x365 mm, ø 200mm, 5,6 W  
116101770



261,00 €

**Kosmetikspiegel**

Cosmetic mirror  
230x280x450 mm, ø 190 mm  
112201514  
112201510



132,00 €

132,00 €



**Doppelseitiger Kosmetikspiegel**

Double-sided cosmetic mirror  
230x300x430 mm, ø 200 mm  
172201510



69,00 €

**Kosmetikspiegel freistehend**

Double-sided cosmetic mirror free standing  
232x385x150 mm, ø 200 mm  
112201254



84,00 €

**Kosmetikspiegel teleskopisch**

Cosmetic mirror, telescopic  
232x370x120 mm, ø 200 mm  
112201414  
112201410



97,00 €

91,00 €



**Kosmetiktuchspender, Edelstahl**

Paper tissue dispenser, stainless steel  
250x75x130 mm  
102303020



65,00 €

**Hygienebeutelspender (HygBag), Kunststoff**

Hygiene bags dispenser (HygBag), plastic  
100x135x25 mm  
101403030



17,00 €

**Abfalleimer "Soft Close"**

Waste bin "Soft Close"  
170x255x170 mm, 3 l  
104315020

27,00 €

**Abfalleimer „Soft-Close“**

Waste bin "Soft Close"  
200x280x200 mm, 5 l  
104315014  
104315010

36,00 €

36,00 €

# OBLA/STELLA



material  
material

## Kleiderhaken

Single robe hook  
54x54x72 mm

165206022  
166206022

   
28,00 €  
35,00 €

## Kleiderhaken

Single robe hook  
54x54x56 mm

165106062  
166106062

   
20,00 €  
27,00 €

## Toilettenpapierhalter mit Deckel

Toilet paper holder with cover  
136x194x116 mm

165212012  
166212012

   
65,00 €  
73,00 €

## Toilettenpapierhalter

Toilet paper holder  
138x118x72 mm

165112222  
166112222

   
54,00 €  
62,00 €

Zink  
zinc

Glas  
glass



Oberflächenfinish  
Surface finish

## Toilettenpapierhalter

Toilet paper holder  
178x54x72 mm

165212032  
166212032

   
42,00 €  
50,00 €

## Reservetoilettenpapierhalter

Spare toilet paper holder  
54x158x72 mm

165112032  
166112032

   
35,00 €  
43,00 €

## WC-Bürstengarnitur, hängend

Wall mounted toilet brush holder  
110x370x145 mm

165113012  
166113012

   
63,00 €  
71,00 €

## Seifenschale

Soap dish  
110x54x130 mm

165108042  
166108042

   
47,00 €  
54,00 €

poliert  
polished



## Zahnglshalter

Toothbrush holder  
80x140x120 mm

165110012  
166110012

   
47,00 €  
54,00 €

## Seifenspender

Soap dispenser  
82x190x130 mm, 300 ml

165109017  
166109017

   
98,00 €  
105,00 €

## Handtuchhalter

Towel holder  
654x54x214 mm

165205082  
166205082

   
136,00 €  
151,00 €

## Dreifachhaken, schwenkbar

Hanger with 3 hooks, swivel  
54x193x135 mm

165206072  
166206072

   
77,00 €  
92,00 €



## Handtuchhalter

Towel holder  
354x54x72 mm

165204012  
166204012

   
56,00 €  
71,00 €

## Handtuchhalter

Towel holder  
654x54x72 mm

165204042  
166204042

   
68,00 €  
84,00 €

## Doppel - Handtuchhalter

Double towel holder  
654x54x122 mm

165204052  
166204052

   
94,00 €  
109,00 €

## Zweiarmliger Handtuchhalter, schwenkbar

Double towel holder, swivel  
54x163x445 mm

165204102  
166204102

   
70,00 €  
88,00 €



## Handtuchring

Ring towel holder  
168x173x72 mm

165204062  
166204062

   
43,00 €  
50,00 €

## Dreiarmliger Handtuchhalter, schwenkbar

Triple swivel towel holder  
54x193x445 mm

165204112  
166204112

   
88,00 €  
103,00 €

## Handtuchhalter

Towel holder with rail  
654x107x214 mm

165205072  
166205072

  
170,00 €  
186,00 €

# circum/quadra

168XXXXXX

169XXXXXX



## Kleiderhaken

Single robe hook

52×52×40 mm

168106062

169106062

10,00 €

11,00 €

## Doppelkleiderhaken

Double robe hook

86×52×63 mm

168106032

169106032

17,00 €

18,00 €

## Set CIRCUM/QUADRA, 2 St.

Set CIRCUM/QUADRA, 2 pcs

204682

204692

55,00 €

56,00 €

## Set CIRCUM/QUADRA, 3 St.

Set CIRCUM/QUADRA, 3 pcs

204683

204693

69,00 €

70,00 €



## Toilettenpapierhalter mit Deckel

Toilet paper holder with cover

137×140×55 mm

168112012

169112012

35,00 €

33,00 €

## Toilettenpapierhalter

Toilet paper holder

137×110×55 mm

168112042

169112042

32,00 €

33,00 €

## Toilettenpapierhalter, rechts

Toilet paper holder, right

170×52×80 mm

168212032

169212032

25,00 €

26,00 €

## Toilettenpapierhalter, links

Toilet paper holder, left

170×52×80 mm

168212032L

169212032L

25,00 €

26,00 €



## Reservetoilettenpapierhalter

Spare toilet paper holder

52×170×80 mm

168112032

169112032

25,00 €

26,00 €

## WC-Bürstengarnitur, hängend

Wall mounted toilet brush holder

113×360×130 mm

168113012

169113012

33,00 €

34,00 €

## Seifenschale

Soap dish

110×57×130 mm

168108042

169108042

22,00 €

23,00 €

## Zahnglashalter

Toothbrush holder

65×95×110 mm

168110012

169110012

21,00 €

22,00 €



## Seifenspender

Soap dispenser

68×155×125 mm, 200 ml

168109017

169109017

33,00 €

34,00 €

## Glasablage

Glass shelf

520×52×136 mm

168102042

169102042

35,00 €

35,00 €

## Handtuchhalter

Towel holder

352×52×75 mm

168204012

169204012

35,00 €

36,00 €

## Handtuchhalter

Towel holder

502×52×75 mm

168204022

169204022

35,00 €

37,00 €



## Handtuchhalter

Towel holder

652×52×75 mm

168204042

169204042

36,00 €

38,00 €

## Zweiarmiger Handtuchhalter, schwenkbar

Double towel holder, swivel

52×52×420 mm

168204192

169204192

32,00 €

33,00 €

## Handtuchring

Ring towel holder

168×166×60 mm

168104062

169104062

35,00 €

35,00 €

material

Zink

Glas

Oberflächenfinish

Surface finish

poliert

polished

# Nero



material  
material

Messing  
brass

Glas  
glass

Oberflächenfinish  
Surface finish

schwarz  
Lack  
black  
lacquer

matt  
matt

**Kleiderhaken**  
Single robe hook  
17×38×30 mm  
135006010

17,00 €

**Doppelkleiderhaken**  
Double robe hook  
80×28×39 mm  
135006030

26,00 €

**Doppelkleiderhaken**  
Double robe hook  
37×26×30 mm  
135006230

21,00 €



**Kleiderhaken**  
Single robe hook  
25×67×32 mm  
135106020

18,00 €

**Doppelkleiderhaken**  
Double robe hook  
83×46×33 mm  
135106030

27,00 €

**Hakenleiste mit 4 Haken**  
Rail with 4 robe hooks  
205×46×33 mm  
135105210

52,00 €



**Toilettenpapierhalter**  
Toilet paper holder  
179×28×59 mm  
135012020

41,00 €

**Toilettenpapierhalter**  
Toilet paper holder  
131×90×75 mm  
135012220

55,00 €

**Toilettenpapierhalter mit Deckel**  
Toilet paper holder with cover  
130×95×90 mm  
135012010

68,00 €

**Reservetoilettenpapierhalter**  
Spare toilet paper holder  
20×178×59 mm  
135112030

41,00 €



**WC-Bürstengarnitur, stehend/hängend**  
Toilet brush holder, free standing/wall mounted  
85×375×85 mm  
135913160

152,00 €

**WC-Bürstengarnitur, hängend**  
Wall mounted toilet brush holder  
93×375×127 mm  
135013010

73,00 €

**WC-Bürstengarnitur, stehend/hängend**  
Toilet brush holder, free standing/wall mounted  
80×400×80 mm  
135913090

130,00 €



**Seifenablage mit Glasschale**

Soap dish holder  
103×42×117 mm  
135008020



48,00 €



**Zahnglshalter**

Holder with glass  
64×100×97 mm  
135011010



48,00 €



**Seifenspender**

Soap dispenser  
75×116×95 mm, 250 ml  
139309310



106,00 €

**Seifenspender**

Soap dispenser, glass  
65×150×120 mm  
135009040



82,00 €

**Wannengriff**

Bath grab bar  
320×40×60 mm  
135507670



102,00 €



**Handtuchring**

Ring towel holder  
220×20×110 mm  
135004060



63,00 €



**Handtuchhalter**

Towel holder  
600×20×59 mm  
135004040



92,00 €



**Zweiarmiger Handtuchhalter, schwenkbar**

Double towel holder, swivel  
47×34×445 mm  
135004100



130,00 €



**Doppelhandtuchhalter**

Double towel holder  
500×20×132 mm  
135004080



143,00 €



**Handtuchhalter**

Towel holder  
500×20×205 mm  
135002180



195,00 €



**Glasablage**

Glass shelf  
600×19×118 mm  
135002240



55,00 €

# LIVING



material  
material

Edelstahl  
stainless steel

Glas  
glass

Oberflächenfinish  
Surface finish

schwarz  
matt  
black matt

## Kleiderhaken

Single robe hook

28×53×21 mm

101506300

11,00 €



## Kleiderhaken

Single robe hook

28×113×21 mm

101506310

12,00 €



## Doppelter Seifenspenderhalter

Double holder for soap dispenser

163×60×90 mm

101519020

41,00 €



## Toilettenpapierhalter

Toilet paper holder

126×120×133 mm

101512230

58,00 €



## Ablage

Metal shelf

400×120×90 mm

101502420

66,00 €



## WC-Bürstengarnitur, hängend

Wall mounted toilet brush holder

123×360×106 mm

101513180

58,00 €



## Reservepapierrollenhalter

Spare toilet paper holder

126×190×133 mm

101512030

58,00 €



## Ablage

Metal shelf

400×70×90 mm

101502390

58,00 €



## Ablage

Metal shelf

500×70×90 mm

101502400

64,00 €



## Ablage

Metal shelf

600×70×90 mm

101502410

69,00 €



## Papierhandtuchspender

Paper towel dispenser

280×220×128 mm

101503040

84,00 €





### Doppelkleiderhaken

Double robe hook

48×85×22 mm

101106035



### Hakenleiste mit 5 Haken

Rail with 5 robe hooks

180×68×22 mm

101106045



### Toilettenpapierhalter

Toilet paper holder

155×57×80 mm

101106025



20,00 €



36,00 €



41,00 €

material  
material

Edelstahl  
stainless  
steel



### Seifenspender

Soap dispenser

66×165×120 mm, 300 ml

101109225



### Seifenspender

Soap dispenser

66×235×120 mm, 500 ml

101109095



102,00 €



116,00 €



46,00 €

Oberflächenfinish  
Surface finish



matt  
matt

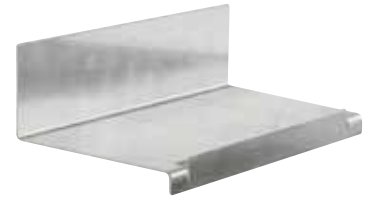

### Ablage

Shelf

180×50×97 mm

101102365



39,00 €



### Toilettenpapierhalter mit Ablage

Toilet paper holder with shelf

270×57×80 mm

101104015



102,00 €



116,00 €



46,00 €

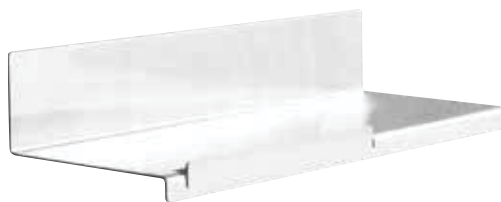

### Ablage

Shelf

300×50×97 mm

101102225



51,00 €



### Handtuchhalter

Towel holder

335×50×70 mm

101112135



### WC-Bürstengarnitur, hängend

Wall mounted toilet brush holder

115×370×110 mm

101113091



47,00 €



94,00 €

# via



material  
material

Messing  
brass

Glas  
glass

Oberflächenfinish  
Surface finish

Chrom  
chrome



poliert  
polished

**Kleiderhaken**  
Single robe hook  
17×38×30 mm  
135006012

14,00 €

**Doppelkleiderhaken**  
Double robe hook  
37×26×30 mm  
135006232

19,00 €

**Kleiderhaken**  
Single robe hook  
25×70×48 mm  
102306172

19,00 €



**Doppelkleiderhaken**  
Double robe hook  
80×28×39 mm  
135006032

24,00 €

**Toilettenpapierhalter**  
Toilet paper holder  
179×28×59 mm  
135012022  
135012022L

38,00 €

**Toilettenpapierhalter**  
Toilet paper holder  
131×90×75 mm  
135012222

44,00 €

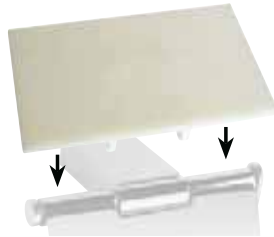

**Toilettenpapierhalter mit Deckel**  
Toilet paper holder with cover  
130×95×90 mm  
135012012

59,00 €

**Toilettenpapierhalter mit Handy-Ablage**  
Mobile phone shelf for toilet paper holder  
132×27×78 mm  
131567032

15,00 €

**Reservetoilettenpapierhalter**  
Spare toilet paper holder  
20×300×55 mm  
135112032

38,00 €

**Reservetoilettenpapierhalter**  
Spare toilet paper holder extended  
20×300×55 mm  
135012032

52,00 €



**WC-Bürstengarnitur, hängend**  
Wall mounted toilet brush holder  
93×385×127 mm  
135013012

68,00 €

**WC-Bürstengarnitur, stehend/hängend**  
Toilet brush holder, free standing/wall mounted  
85×440×85 mm  
118113092

75,00 €

**WC-Bürstengarnitur, stehend**  
Toilet brush holder, free standing  
80×400×80 mm  
135913091

92,00 €

! Bis zum Ausverkauf.  
! Till sold out.

**Seifenspender**

Soap dispenser, glass

64×150×120 mm, 250 ml

135009042



73,00 €

**Zahnglshalter**

Holder with glass

63×100×97 mm

135011012



48,00 €

**Seifenablage mit Glasschale**

Soap dish holder

103×42×117 mm

135008022



48,00 €

**Seifenablage, stehend**

Soap dish, free standing

90×18×90 mm

139108192

66,00 €

**Leiste mit 3 Haken**

Hanger with 3 hooks

174×30×37 mm

135006242



48,00 €

**Leiste mit 5 Haken**

Hanger with 5 hooks

310×30×37 mm

135006252



86,00 €

**Handtuchhalter**

Towel holder

450×20×59 mm

135004022

600×20×59 mm

135004042



81,00 €

135004043

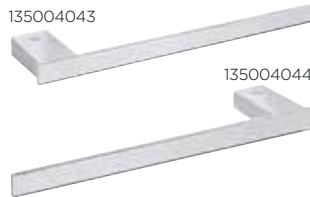

135004044

**Handtuchhalter**

Towel holder

297×20×59 mm

135004043

135004044



52,00 €

**Zweiarmiger Handtuchhalter, schwenkbar**

Double towel holder, swivel

46×32×445 mm

135004102



108,00 €

**Doppelhandtuchhalter**

Double towel holder

500×20×132 mm

135004082



136,00 €

**Handtuchring**

Ring towel holder

220×20×110 mm

135004062



61,00 €

**Handtuchhalter**

Towel holder

500×20×205 mm

135002182



190,00 €

**Glasablage**

Glass shelf

600 × 19 × 118 mm

135002242

500 × 19 × 118 mm

135002352



48,00 €

**Wannengriff**

Bath grab bar

320×40×60 mm

135007072



114,00 €

# SOLO



material  
material

### Kleiderhaken

Single robe hook

47×47×35 mm

139106172



9,00 €



### Kleiderhaken

Single robe hook

25×67×32 mm

139106022



15,00 €



### Doppelkleiderhaken

Double hook

83×46×33 mm

139106032



22,00 €



### Hakenleiste mit 4 Haken

Rail with 4 robe hooks

205×46×33 mm

139105212



43,00 €

Messing  
brass

Glas  
glass

Oberflächenfinish  
Surface finish

Chrom  
chrome

poliert  
polished



### Toilettenpapierhalter

Toilet paper holder

129×25×82 mm

139112022



38,00 €



### Toilettenpapierhalter mit Deckel

Toilet paper holder with cover

128×64×130 mm

139112012



61,00 €



### WC-Bürstengarnitur, hängend

Wall mounted toilet brush holder

83×390×93 mm

139113142



58,00 €



### WC-Bürstengarnitur, stehend/hängend

Toilet brush holder, free standing/wall mounted

85×375×85 mm

139113162



127,00 €



### Seifenablage mit Glasschale

Soap dish holder

104×45×110 mm

139108032



38,00 €



### Zahnglhalter

Toothbrush holder

75×101×91 mm

139110012



38,00 €



### Seifenspender

Soapdispenser with glass

75×116×95 mm, 250 ml

139309312



107,00 €



### Seifenspender

Soap dispenser, glass

75×170×91 mm, 250 ml

139109042



59,00 €



### Handtuchring

Ring towel holder

200×25×82 mm

139104062



47,00 €



### Handtuchhalter

Towel holder

600×25×80 mm

139104282



117,00 €



### Handtuchhalter

Towel holder

800×25×80 mm

139104412



142,00 €



### Doppelhandtuchhalter

Double towel holder

600×25×130 mm

139104052



147,00 €



### Zweiarmiger Handtuchhalter, schwenkbar

Towel holder

50×35×393 mm

139104232



96,00 €



### Zweiarmiger Handtuchhalter, schwenkbar

Double towel holder, swivel

398,5×47,2×83 mm

139104102



71,00 €



### Handtuchhalter

Towel holder

600×108×255 mm

139105262



318,00 €



### Glasablage

Glass shelf

500×25×120 mm

139102312



167,00 €

# gamma



**Kleiderhaken**  
Single robe hook  
15×42×40 mm  
145804022

36,00 €



**Toilettenpapierhalter**  
Toilet paper holder  
128×98×50 mm  
145812022

76,00 €



**Toilettenpapierhalter mit Deckel**  
Toilet paper holder with cover  
128×135×50 mm  
145812012

94,00 €



**Toilettenpapierhalter**  
Toilet paper holder  
180×36×65 mm  
145812222

56,00 €

material  
material  
Edelstahl  
stainless steel  
Polyresin  
schwarz  
Polyresin  
black  
Polyresin  
weiß  
Polyresin  
white



**Seifenschale**  
Soap dish  
105×45×95 mm  
145408312 schwarz/black  
145508312 weiß/white

84,00 €  
 84,00 €



**Zahnglshalter**  
Toothbrush holder  
115×115×95 mm  
145411012 schwarz/black  
145511012 weiß/white

84,00 €  
 84,00 €

Oberflächenfinish  
Surface finish  
chrom  
chrome  
poliert  
polished



**WC-Bürstengarnitur, hängend**  
Wall mounted toilet brush holder  
125×386×105 mm  
145413092 schwarz/black  
145513092 weiß/white

164,00 €  
 164,00 €



**Seifenspender**  
Soap dispenser  
115×160×95 mm, 200 ml  
145409012 schwarz/black  
145509012 weiß/white

122,00 €  
 122,00 €

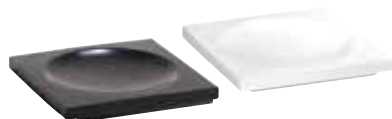

**Glasseifenschale, stehend**  
Soap dish free standing  
95×15×95 mm  
145608310 schwarz/black  
145708314 weiß/white

22,00 €  
22,00 €



**Zahnglshalter, stehend**  
Toothbrush holder, free standing  
75×115×75 mm  
145611310 schwarz/black  
145711314 weiß/white

25,00 €  
25,00 €



**WC-Bürstengarnitur, stehend**  
Toilet brush holder free standing  
92×385×92 mm  
145613310 schwarz/black  
145713314 weiß/white

68,00 €  
68,00 €



**Seifenspender, stehend**

Soap dispenser, free standing

75×160×86 mm, 200 ml

145609310 schwarz/black

61,00 €

145709314 weiß/white

61,00 €



**Seifenablage, stehend, rund**

Round soap dish free standing

110×25×110 mm

145608320 schwarz/black

22,00 €

145708324 weiß/white

22,00 €



**Zahnglshalter, stehend, rund**

Round toothbrush holder free standing

72×120×72 mm

145611320 schwarz/black

23,00 €

145711324 weiß/white

23,00 €



**WC-Bürstengarnitur, stehend, rund**

Round toilet brush holder free standing

98×430×98 mm

145613320 schwarz/black

61,00 €

145713324 weiß/white

61,00 €



**Seifenspender, stehend, rund**

Soap dispenser, free standing

72×175×86 mm, 250 ml

145609320 schwarz/black

34,00 €

145709324 weiß/white

34,00 €



**Handtuchhalter**

Towel holder

300×36×75 mm

145804012

81,00 €



**Handtuchhalter**

Towel holder

600×36×75 mm

145804042

112,00 €



**Zweiarmiger Handtuchhalter, schwenkbar**

Double towel holder, swivel

40×55×420 mm

145804102

134,00 €



**Glasablage**

Glass shelf

600×36×100 mm

145802312

152,00 €

# Niki



### Doppelkleiderhaken

Double robe hook

84×36×60 mm

153106032



16,00 €



### Toilettenpapierhalter mit Deckel

Toilet paper holder with cover

117×140×49 mm

153112012



21,00 €



### Toilettenpapierhalter

Toilet paper holder

126×90×42 mm

153112022



17,00 €

material  
material

Zink  
zinc

Glas  
glass



### Handtuchring

Ring towel holder

228×150×60 mm

153104062



32,00 €



### Hakenleiste mit 4 Haken

Rail with 4 robe hooks

300×53×45 mm

153105112



31,00 €

Oberflächenfinish  
Surface finish



poliert  
polished



### Glasseifenschale

Soap dish holder

100×40×110 mm

153108022



27,00 €



### Zahnglashalter

Holder with glass

77×97×100 mm

153110052



27,00 €



### WC-Bürstengarnitur, hängend

Wall mounted toilet brush holder

105×375×135 mm

153113012



48,00 €



### Seifenspender

Soap dispenser, glass

77×150×100 mm, 250 ml

153209049



40,00 €



### Glasablage

Glass shelf

500×36×115 mm

153102042



31,00 €



### Handtuchhalter

Towel holder

550×36×62 mm

153104042



48,00 €



### Doppelhandtuchhalter

Double towel holder

550×36×117 mm

153104052



78,00 €



### Zweiarmiger Handtuchhalter, schwenkbar

Double towel holder, swivel

50×53×475 mm

153104191



27,00 €



### Dreiarmiger Handtuchhalter, schwenkbar

Triple towel holder, swivel

57×175×350 mm

153104112



34,00 €

# BETA



material  
material

Messing  
brass

Glas  
glass

## Kleiderhaken

Single robe hook

55×55×50 mm

132106022

24,00 €

## Doppelkleiderhaken

Double robe hook

55×55×50 mm

132106032

27,00 €

## Dreifachhaken, drehbar

Triple hook

55×190×135 mm

132206072

61,00 €

## Doppelhaken

Double hook

55×120×90 mm

132405222

45,00 €



Oberflächenfinish  
Surface finish

Chrom  
chrome

## Doppelhaken

Double hook

120×55×50 mm

132405202

41,00 €

## Dreifachhaken

Triple hook

185×55×50 mm

132405232

60,00 €

## Vierfachhaken

Rail with 4 robe hooks

250×55×50 mm

132405212

79,00 €



poliert  
polished



## Kleiderhaken

Single robe hook

19×35×38 mm

132106132

19,00 €

## Kleiderhaken

Single robe hook

55×55×50 mm

132306172

24,00 €

## Toilettenpapierhalter mit Deckel

Toilet paper holder with cover

138×150×80 mm

132112012

54,00 €

## Toilettenpapierhalter

Toilet paper holder

140×95×90 mm

132112042

41,00 €

132212032



132212032L



## Toilettenpapierhalter

Toilet paper holder

180×55×70 mm

132212032

132212032L

45,00 €  
45,00 €

## Reservepapierrollenhalter

Spare toilet paper holder

55×165×65 mm

132112032

35,00 €

## Handtuchring

Ring towel holder

168×188×50 mm

132104062

41,00 €



## Hakenleiste mit 5 Haken

Rail with 5 robe hooks

415×55×70 mm

132105112

59,00 €

## WC-Bürstengarnitur, hängend

Wall mounted toilet brush holder

95×360×140 mm

132113012\*

132113017\*\*

61,00 €  
61,00 €

## WC-Bürstengarnitur, stehend/hängend

Toilet brush holder

wall mounted/free standing

85×440×85 mm

118113092

75,00 €

## WC-Bürstengarnitur, stehend

Toilet brush holder, free standing

80×370×80 mm

135913091

92,00 €

! Bis zum Ausverkauf.  
! Till sold out.



**WC-Bürstengarnitur, stehend**  
Toilet paper holder and toilet brush holder, free standing  
**150×710×255 mm**  
**132836042** **291,00 €**



**Glasseifenschale**  
Soap dish holder  
**110×55×129 mm**  
**132108042** **38,00 €**



**Metallseifenschale**  
Soap dish metallic  
**129×55×110 mm**  
**132208082** **38,00 €**

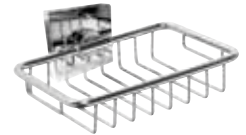

**Seifenkorb**  
Soap basket  
**140×52×125 mm**  
**132108162** **44,00 €**



**Magnetseifenhalter**  
Magnetic soap holder  
**55×55×70 mm**  
**132108202** **39,00 €**



**Seifenspender**  
Soap dispenser  
**80×190×133 mm, 230 ml**  
**132109017** **80,00 €**



**Seifenspender mit Magnetseifenhalter**  
Soap dispenser with magnetic soap holder, glass  
**75×160×100 mm, 200 ml**  
**132109182** **103,00 €**



**Seifenspender**  
Soap dispenser, glass  
**70×145×100 mm, 200 ml**  
**132109102** **74,00 €**



**Zahnglshalter**  
Holder with glass  
**70×95×105 mm**  
**132110012** **40,00 €**



**Doppel-Zahnglshalter**  
Double glass holder  
**160×95×90 mm**  
**132110022** **61,00 €**



**WC-Bürstengarnitur, stehend**  
Toilet paper holder and toilet brush holder, free standing  
**150×710×255 mm**  
**132836012** **266,00 €**



**Zahnglshalter mit Doppelglas**  
Toothbrush holder with glasses  
**190×95×125 mm**  
**132110042** **82,00 €**



**Zahnglshalter**  
Toothbrush holder  
**105×55×85 mm**  
**132110032** **32,00 €**



**Glasablage**  
Glass shelf  
**300×55×130 mm**  
**132122042** **58,00 €**



**Glasablage, Eckmodell**  
Glass shelf, corner model  
**255×55×255 mm**  
**132102012** **61,00 €**



**Glasablage**  
Glass shelf  
**600×55×130 mm**  
**132102042** **62,00 €**



**Glasablage**  
Glass shelf with tiltable rail  
**600×55×130 mm**  
**132102212** **95,00 €**

\*weiße Bürste/white brush  
\*\*black brush/black brush



**Handtuchhalter**

Towel holder

355x55x65 mm

132104012

48,00 €

505x55x65 mm

132104022

52,00 €

655x55x65 mm

132104042

59,00 €



**Doppelhandtuchhalter**

Double towel holder

655x55x110 mm

132104052

68,00 €



**Wannengriff**

Bath grab bar

355x55x80 mm

132307611

82,00 €



**Handtuchhalter**

Towel holder

355x55x65 mm

132204012

54,00 €

505x55x65 mm

132204022

60,00 €

655x55x65 mm

132204042

68,00 €



**Doppelhandtuchhalter**

Double towel holder

655x55x120 mm

132204052

85,00 €



**Handtuchhalter**

Towel holder

655x55x215 mm

132205082

125,00 €



**Handtuchhalter**

Towel holder with rail

655x106x215 mm

132205072

154,00 €



**Doppelhandtuchhalter**

Double Towel holder with rail

655x160x225 mm

132205102

182,00 €



**Zweiarmiger Handtuchhalter, schwenkbar**

Double towel holder, swivel

55x55x420 mm

132204191

67,00 €



**Zweiarmiger Handtuchhalter, schwenkbar**

Double towel holder, swivel

55x165x450 mm

132204102

89,00 €



**Kosmetikspiegel mit Wandstange**

One-sided cosmetic mirror on a pole

200x535x140 mm

132201172

156,00 €



**Föhnhalter**

Hairdryer holder

80x55x100 mm

132117012

41,00 €



**Doppelhandtuchständer**

Free standing double towel holder stand

150x800x400 mm

132836022

266,00 €



**Spiral Föhnhalter**

Hairdryer holder, spiral

105x118x123 mm

132117022

46,00 €



**Glasablagenhalter, Paar, Glasstärke 8 mm**

Glass shelf holder - without glass, pair

55x55x40 mm ≠ 8 mm

132102112

48,00 €

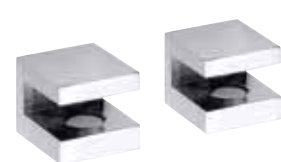

**Glasablagenhalter, Paar, Glasstärke 8 mm**

Glass shelf holder - without glass, pair

20x20x25 mm, ≠ 8 mm

102202112

26,00 €



# easy/easy01

163XXXXXX - 

164XXXXXX - 

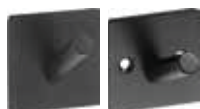

163109220  
schwarz/black

163109221  
poliert/polished



### Kleiderhaken, schwarz

Single robe hook, black

45×45×38 mm

163106260 15,00 €  
164106260 15,00 €

### Kleiderhaken, poliert

Single robe hook, polished

45×45×38 mm

163106261 14,00 €  
164106261 14,00 €

### Kleiderhaken, gebürstet

Single robe hook, brushed

45×45×38 mm

163106265 12,00 €  
164106265 12,00 €

material  
material

Edelstahl  
stainless  
steel



### Seifenspender

Soap dispenser

66×165×120 mm, 300 ml

163109220 116,00 €  
163109221 116,00 €

### Kleiderhaken, schwarz

Single robe hook, black

45×45×36 mm

163106360 15,00 €  
164106360 15,00 €

### Kleiderhaken, poliert

Single robe hook, polished

45×45×36 mm

163106361 14,00 €  
164106361 14,00 €

### Kleiderhaken, gebürstet

Single robe hook, brushed

45×45×36 mm

163106365 12,00 €  
164106365 12,00 €

Oberflächenfinish  
Surface finish



schwarz  
black



poliert  
polished



mat  
mat

163109090  
schwarz/black

163109091  
poliert/polished



### Doppelhaken, schwarz

Hanger with 2 hooks, black

115×45×38 mm

163106270 28,00 €  
164106270 28,00 €

### Doppelhaken, poliert

Hanger with 2 hooks, polished

115×45×38 mm

163106271 26,00 €  
164106271 26,00 €

### Doppelhaken, gebürstet

Hanger with 2 hooks, brushed

115×45×38 mm

163106275 23,00 €  
164106275 23,00 €



### Seifenspender

Soap dispenser

66×235×120 mm, 500 ml

163109090 132,00 €  
163109091 132,00 €

### Doppelhaken, schwarz

Hanger with 2 hooks, black

115×45×36 mm

163106370 27,00 €  
164106370 27,00 €

### Doppelhaken, poliert

Hanger with 2 hooks, polished

115×45×36 mm

163106371 26,00 €  
164106371 26,00 €

### Doppelhaken, gebürstet

Hanger with 2 hooks, brushed

115×45×36 mm

163106375 23,00 €  
164106375 23,00 €



### Hakenleiste mit 4 Haken, schwarz

Hanger with 4 hook, black

255×45×38 mm

163106290 47,00 €  
164106290 47,00 €

### Hakenleiste mit 4 Haken, poliert

Hanger with 4 hook, polished

255×45×38 mm

163106291 43,00 €  
164106291 43,00 €

### Hakenleiste mit 4 Haken, gebürstet

Hanger with 4 hook, mat

255×45×38 mm

163106295 40,00 €  
164106295 40,00 €



**Hakenleiste mit 4 Haken, schwarz**

Hanger with 4 hook, black

255×45×36 mm

163106390

47,00 €

164106390

47,00 €



**Hakenleiste mit 4 Haken, poliert**

Hanger with 4 hook, polished

255×45×36 mm

163106391

45,00 €

164106391

45,00 €



**Hakenleiste mit 4 Haken, gebürstet**

Hanger with 4 hook, mat

255×45×36 mm

163106395

40,00 €

164106395

40,00 €



**Toilettenpapierhalter, schwarz**

Toilet paper holder, black

145×100×42 mm

163112220

44,00 €

164112220

44,00 €



**Toilettenpapierhalter, poliert**

Toilet paper holder, polished

145×100×42 mm

163112221

38,00 €

164112221

38,00 €



**Toilettenpapierhalter, gebürstet**

Toilet paper holder, mat

145×100×42 mm

163112225

36,00 €

164112225

36,00 €



**Toilettenpapierhalter, schwarz**

Toilet paper holder, black

145×100×42 mm

163112020

44,00 €

164112020

44,00 €



**Toilettenpapierhalter, poliert**

Toilet paper holder, polished

145×100×42 mm

163112021

38,00 €

164112021

38,00 €



**Toilettenpapierhalter, gebürstet**

Toilet paper holder, mat

145×100×42 mm

163112025

36,00 €

164112025

36,00 €



**Reservetoilettenpapierhalter, schwarz**

Spare toilet paper holder, black

45×180×74 mm

163112230

25,00 €

164112230

25,00 €



**Reservetoilettenpapierhalter, poliert**

Spare toilet paper holder, polished

45×180×74 mm

163112231

23,00 €

164112231

23,00 €



**Reservetoilettenpapierhalter, gebürstet**

Spare toilet paper holder, mat

45×180×74 mm

163112235

20,00 €

164112235

20,00 €



**Reservetoilettenpapierhalter, schwarz**

Spare toilet paper holder, black

45×180×74 mm

163112030

25,00 €

164112030

25,00 €



**Reservetoilettenpapierhalter, poliert**

Spare toilet paper holder, polished

45×180×74 mm

163112031

23,00 €

164112031

23,00 €



**Reservetoilettenpapierhalter, gebürstet**

Spare toilet paper holder, mat

45×180×74 mm

163112035

20,00 €

164112035

20,00 €

**WC-Bürstengarnitur, hängend, schwarz**

Wall mounted toilet brush holder, black

80×355×97 mm / 105×355×96

163113060

63,00 €

164113060

63,00 €

**WC-Bürstengarnitur, hängend, poliert**

Wall mounted toilet brush holder, polished

80×355×97 mm / 105×355×96

163113061

53,00 €

164113061

53,00 €

**WC-Bürstengarnitur, hängend, gebürstet**

Wall mounted toilet brush holder, mat

80×355×97 mm / 105×355×96

163113065

48,00 €

164113065

48,00 €

**Handtuchhalter, schwarz**

Towel holder, black

645×72×74 mm

163104040

49,00 €

164104040

49,00 €

**Handtuchhalter, schwarz**

Towel holder, black

645×72×74 mm

163104240

49,00 €

164104240

49,00 €

**Handtuchhalter, poliert**

Towel holder, polished

645×72×74 mm

163104041

42,00 €

164104041

42,00 €

**Handtuchhalter, poliert**

Towel holder, polished

645×72×74 mm

163104241

42,00 €

164104241

42,00 €

**Handtuchhalter, gebürstet**

Towel holder, mat

645×72×74 mm

163104045

38,00 €

164104045

38,00 €

**Handtuchhalter, gebürstet**

Towel holder, mat

645×72×74 mm

163104245

38,00 €

164104245

38,00 €

# ALFA/NOX

XXXXXXXXX2      XXXXXXXXXXX0



material

## Doppelkleiderhaken

Double robe hook  
70×60×50 mm

102406022      13,00 €  
102406020      13,00 €

Zink  
zinc

Glas  
glass

Oberflächenfinish  
Surface finish

poliert  
polished

schwarz  
black

## Toilettenpapierhalter

Toilet paper holder  
180×125×60 mm

102414012      25,00 €

## Toilettenpapierhalter

Toilet paper holder  
138×103×55 mm

102414010      25,00 €



## Toilettenpapierhalter mit Deckel

Toilet paper holder with cover  
138×135×59 mm

102512012      28,00 €  
102512010      28,00 €

## Reservetoilettenpapierhalter

Spare paper holder  
60×168×75 mm

102512032      20,00 €

## WC-Bürstengarnitur, hängend

Wall mounted toilet brush holder  
115×385×140 mm

102413012      44,00 €

## WC-Bürstengarnitur, hängend

Wall mounted toilet brush holder  
113×385×150 mm

102413010      44,00 €



## Zahnglshalter

Toothbrush holder  
68×95×115 mm

102410012      21,00 €  
102410010      21,00 €

## Seifenspender

Soap dispenser  
68×150×115 mm, 200 ml

102408022      41,00 €

## Seifenspender

Soap dispenser  
68×165×125 mm

102408020      41,00 €

## Glasseifenschale

Soap dish  
110×60×138 mm

102408023      23,00 €  
102408030      23,00 €



## Handtuchhalter

Towel holder  
610×60×75 mm

102404282      39,00 €

## Doppelhandtuchhalter

Double towel holder  
600×60×155 mm

102410052      57,00 €

## Zweiarmiger Handtuchhalter, schwenkbar

Double towel holder, swivel  
60×65×475 mm

102404101      38,00 €



## Handtuchring

Ring towel holder  
212×170×55 mm

102502062      29,00 €

## Glasablage

Glass shelf  
600×22×125 mm

102402242      47,00 €

## Glasablage

Glass shelf with rail  
620×60×150 mm

102402243      70,00 €

# retro



**Chrom**  
chrome  
1443XXXXX



**Gold-Chrom**  
gold-chrome  
1442XXXXX



**Bronze**  
bronze  
1441XXXXX



## Kleiderhaken

Single robe hook

65×65×65 mm

- 144306132 chrom/chrome
- 144206138 gold-chrom/gold-chrome
- 144106137 bronze/bronze



25,00 €  
33,00 €  
36,00 €

## Kleiderhaken

Single robe hook

65×65×65 mm

- 144306012 chrom/chrome
- 144206018 gold-chrom/gold-chrome
- 144106017 bronze/bronze



27,00 €  
31,00 €  
41,00 €



## Doppelkleiderhaken

Double robe hook

65×65×65 mm

- 144306032 chrom/chrome
- 144206038 gold-chrom/gold-chrome
- 144106037 bronze/bronze



31,00 €  
36,00 €  
45,00 €

## Toilettenpapierhalter mit Deckel

Toilet paper holder with cover

140×150×100 mm

- 144312012 chrom/chrome
- 144212018 gold-chrom/gold-chrome
- 144112017 bronze/bronze



57,00 €  
68,00 €  
86,00 €



## Toilettenpapierhalter

Toilet paper holder

135×100×90 mm

- 144312022 chrom/chrome
- 144212028 gold-chrom/gold-chrome
- 144112027 bronze/bronze



43,00 €  
50,00 €  
65,00 €

## Reservepapierrollenhalter

Spare toilet paper holder

65×170×65 mm

- 144312032 chrom/chrome
- 144212038 gold-chrom/gold-chrome
- 144112037 bronze/bronze



41,00 €  
48,00 €  
65,00 €



## WC-Bürstengarnitur, hängend

Wall mounted toilet brush holder

110×375×145 mm

- 144313012 chrom/chrome
- 144213018 gold-chrom/gold-chrome
- 144113017 bronze/bronze



65,00 €  
68,00 €  
93,00 €

## Handtuchring

Ring towel holder

160×190×65 mm

- 144304062 chrom/chrome
- 144204068 gold-chrom/gold-chrome
- 144104067 bronze/bronze



47,00 €  
51,00 €  
67,00 €

material  
material

Messing  
brass

Glas  
glass

Oberflächenfinish  
Surface finish

Chrom  
chrome

poliert  
polished

Titan/  
Chrom  
titanium/  
chrome

poliert  
polished

bronze  
bronze

matt  
matt



**Glasseifenschale**

Soap dish holder

110×65×138 mm

- 144308022 chrom/chrome
- 144208028 gold-chrom/gold-chrome
- 144108027 bronze/bronze



- 43,00 €
- 50,00 €
- 58,00 €

**Seifenkorb**

Soap basket

140×65×142 mm

- 144308162 chrom/chrome
- 144208168 gold-chrom/gold-chrome
- 144108167 bronze/bronze



- 50,00 €
- 55,00 €
- 76,00 €



**Seifenspender**

Soap dispenser, glass

75×150×120 mm, 200ml

- 144309102 chrom/chrome
- 144209108 gold-chrom/gold-chrome
- 144109107 bronze/bronze



- 86,00 €
- 102,00 €
- 106,00 €

**Seifenspender**

Soap dispenser, glass

80×190×120 mm, 230ml

- 144309012 chrom/chrome
- 144209018 gold-chrom/gold-chrome
- 144109017 bronze/bronze



- 89,00 €
- 109,00 €
- 106,00 €



**Zahnglashalter**

Holder with glass

70×95×115 mm

- 144310012 chrom/chrome
- 144210018 gold-chrom/gold-chrome
- 144110017 bronze/bronze



- 43,00 €
- 50,00 €
- 58,00 €

**Doppel-Zahnglashalter**

Double toothbrush holder

160×95×90 mm

- 144310022 chrom/chrome
- 144210028 gold-chrom/gold-chrome
- 144110027 bronze/bronze



- 65,00 €
- 68,00 €
- 89,00 €



**Handtuchhalter**

Towel holder

365×65×65 mm

- 144304012 chrom/chrome
- 144204018 gold-chrom/gold-chrome
- 144104017 bronze/bronze



- 52,00 €
- 68,00 €
- 89,00 €

**Handtuchhalter**

Towel holder

665×65×65 mm

- 144304042 chrom/chrome
- 144204048 gold-chrom/gold-chrome
- 144104047 bronze/bronze



- 68,00 €
- 81,00 €
- 123,00 €



**Doppelhandtuchhalter**

Double towel holder

665×65×120 mm

- 144304052 chrom/chrome
- 144204058 gold-chrom/gold-chrome
- 144104057 bronze/bronze



- 119,00 €
- 123,00 €
- 137,00 €

**Handtuchhalter**

Towel holder

665×65×225 mm

- 144302182 chrom/chrome
- 144202188 gold-chrom/gold-chrome
- 144102187 bronze/bronze



- 123,00 €
- 137,00 €
- 209,00 €



**Handtuchhalter**

Towel holder with rail  
 665×120×225 mm  
 144302092 chrom/chrome  
 144202098 gold-chrom/gold-chrome

149,00 €  
 178,00 €



**DoppelHandtuchhalter**

Double Towel holder with rail  
 665×165×225 mm  
 144202258 gold-chrom/gold-chrome  
 144102257 bronze/bronze

35,00 €  
 41,00 €



! Bis zum Ausverkauf.  
 • Till sold out.



**Doppelhandtuchhalter**

Double towel holder  
 665×125×115 mm  
 144304232 chrom/chrome  
 144204238 gold-chrom/gold-chrome  
 144104237 bronze/bronze

119,00 €  
 113,00 €  
 164,00 €



**Glasablage**

Glass shelf  
 600×87×120 mm  
 144302242 chrom/chrome  
 144202248 gold-chrom/gold-chrome  
 144102247 bronze/bronze

93,00 €  
 112,00 €  
 144,00 €



**Glasablage**

Glass shelf with tiltable rail  
 600×90×125 mm  
 144302262 chrom/chrome  
 144202268 gold-chrom/gold-chrome  
 144102267 bronze/bronze

100,00 €  
 123,00 €  
 170,00 €



**Doppel-Glasablage**

Double glass shelf with rail  
 400×420×120 mm  
 144301122 chrom/chrome  
 144202128 gold-chrom/gold-chrome

189,00 €  
 202,00 €



**Taschentuchbox, Bronze**

Paper tissue dispenser  
 250×130×70 mm  
 102303022

78,00 €

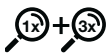

**Kosmetikspiegel, Bronze**

Cosmetic mirror, bronze  
 180×250×360 mm, ø 133 mm  
 106101697

116,00 €

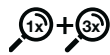

**Kosmetikspiegel, Gold**

Cosmetic mirror, gold  
 180×250×360 mm, ø 133 mm  
 106101698

116,00 €



**Doppelseitiger Kosmetikspiegel**

Double-sided cosmetic mirror  
 185×260×420 mm, ø 140 mm  
 106301122

51,00 €

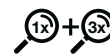

**Abfalleimer**

Waste bin  
 170×260×170 mm, 3 l  
 104315023

78,00 €

# cytro



material  
material

Messing  
brass

Edelstahl  
stainless steel

Kunststoff  
plastic

Oberflächenfinish  
Surface finish

Chrom  
chrome



poliert  
polished



matt  
matt

schwarz  
black

Lack  
lacquer



matt  
matt

## Eckduschablage

Tile-joint shower shelf

300×2×135 mm

101302401 poliert/polished

101302405 gebürstet/brush

101302400 schwarz/black

96,00 €

96,00 €

96,00 €

## Eckduschablage

Tile-joint shower shelf

297×2×210 mm

101302421 poliert/polished

101302425 gebürstet/brush

101302420 schwarz/black

96,00 €

96,00 €

96,00 €

## Eckduschablage

Tile-joint shower shelf

297×2×210 mm

101302441 poliert/polished

101302445 gebürstet/brush

101302440 schwarz/black

96,00 €

96,00 €

96,00 €



## Eckduschablage

Tile-joint shower shelf

300×15×135 mm

101302411 poliert/polished

101302415 gebürstet/brush

101302410 schwarz/black

102,00 €

102,00 €

102,00 €

## Eckduschablage

Tile-joint shower shelf

297×2×210 mm

101302431 poliert/polished

101302435 gebürstet/brush

101302430 schwarz/black

102,00 €

102,00 €

102,00 €

## Eckduschablage

Tile-joint shower shelf

297×2×210 mm

101302451 poliert/polished

101302455 gebürstet/brush

101302450 schwarz/black

102,00 €

102,00 €

102,00 €



## Eckduschablage, poliert

Corner shower shelf, polished

Dusche, poliert

260×70×200 mm



105,00 €

## Eckduschablage, poliert

Corner shower shelf, polished

Dusche, poliert

260×70×200 mm



118,00 €

## Duschablage, poliert

Shower shelf, polished

250×70×105 mm



98,00 €

## Duschablage, poliert

Shower shelf, polished

400×75×110 mm



136,00 €



## Seifenablage mit Duschabzieher, poliert

Shower shelf with plastic tray, polished

225×63×115 mm

102208302

102208304

104,00 €

104,00 €

## Seifenablage mit Duschabzieher, poliert

Shower shelf with spatula, polished

225×63×115 mm

102208292

102208294

145,00 €

145,00 €



## Duschkorb zum Einhängen, poliert

Hang wire basket for tap

250×455×132 mm

153308332

88,00 €

## Eckduschablage mit Kunststoff schale, poliert

Soap basket with plastic tray, polished

280×75×160 mm

102208272

88,00 €

## Eckduschkorb, poliert

Corner Shower shelf, polished

311×45×210 mm

102308061

83,00 €

## Duschablage, poliert

Shower shelf, polished

300×26×115 mm

102308081

69,00 €



**Seifenablage, schwarz**

Shower shelf, black  
300×26×115 mm  
102308080

78,00 €

**Eckduschablage, poliert**

Corner Shower shelf, polished  
205×25×110 mm  
102308051  
262×35×142 mm  
102308261

37,00 €  
45,00 €



**Eckduschablage, poliert**

Corner Shower shelf, polished  
340×65×205 mm  
146208192

113,00 €

**Eckduschablage, poliert**

Corner Shower shelf, polished  
335×65×250 mm  
146208212

128,00 €

**Eckduschablage, poliert**

Corner Shower shelf, polished  
305×55×220 mm  
146208016

65,00 €

**Duschablage, poliert**

Shower shelf, polished  
300×55×125 mm  
146208036

61,00 €



**Acryl Duschablage, weiß**

Corner shower shel, acrylic, polished  
250×75×110 mm  
146208406

88,00 €

**Acryl Duschablage, weiß**

Corner shower shel, acrylic, polished  
265×70×200 mm  
146208376

88,00 €

**Acryl Duschablage, schwarz**

Corner shower shel, acrylic, polished  
250×78×110 mm  
146208396

88,00 €



**Acryl Eckduschablage, schwarz**

Corner shower shel, acrylic, polished  
265×70×200 mm  
146208386

88,00 €

**Eckduschablage, Kunststoff, poliert**

Corner soap basket, plastic, polished  
315×67×235 mm  
102308216

74,00 €

**Duschablage, Kunststoff, poliert**

Soap basket, plastic, polished  
279×65×139 mm  
102308226

65,00 €

**Eckduschablage, Kunststoff, schwarz**

Corner shower shelf, plastic, black  
290×47×220 mm  
153102390

58,00 €



**Duschkorb, poliert**

Shower shelf, polished  
320×60×130 mm  
146208112  
235×58×130 mm  
146208122

61,00 €  
52,00 €

**Duschkorb, poliert**

Shower shelf, polished  
320×110×135 mm  
146208142  
210×110×135 mm  
146208152

65,00 €  
57,00 €

**Duschkorb, poliert**

Shower shelf, polished  
155×25×100 mm  
146208132

37,00 €

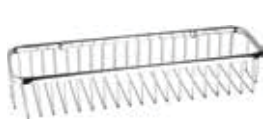

**Duschkorb, poliert**

Shower shelf, polished

405×70×120mm

146208252



76,00 €



**Duschkorb, poliert**

Shower shelf, polished

305×90×145mm

146208262



67,00 €



**Duschkorb, poliert**

Shower shelf, polished

305×70×125mm

146208272



62,00 €



**Duschkorb, poliert**

Shower shelf, polished

305×40×145mm

146208282



59,00 €



**Duschkorb, poliert**

Shower shelf, polished

250×70×112 mm

146208172



86,00 €



**Duschkorb, poliert**

Shower shelf, polished

250×75×110mm

146208362



81,00 €

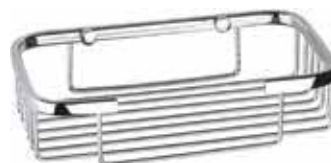

**Duschkorb, poliert**

Shower shelf, polished

210×50×120mm

146208292



45,00 €



**Duschkorb, poliert**

Shower shelf, polished

130×30×90mm

146208302



33,00 €



**Eckduschkorb, poliert**

Corner Shower shelf, polished

265×90×205mm

146208312



64,00 €



**Eckduschkorb, poliert**

Corner Shower shelf, polished

265×40×205mm

146208322



59,00 €

104308172  
mat/matt



104308175  
poliert/  
polished



**Eckduschkorb**

Corner soap basket

230×30×130 mm

104308172

104308175



43,00 €

38,00 €



**Zweistöckiges Duschregal zum Einhängen, poliert**

Double hanging shower shelf, polished

170×700×260mm

104702172

155,00 €



**Eckduschkorb, poliert**

Corner Shower shelf, polished

300×80×230 mm

146208332



82,00 €



**Eckduschkorb, poliert**

Corner Shower shelf, polished

260×70×185mm

146208352



90,00 €



**Eckduschkorb, poliert**

Corner Shower shelf, polished

173×30×111mm

106308172



38,00 €



**Eckduschkorb, poliert**

Corner Shower shelf, polished

245×60×150mm

102308122



48,00 €



**Eckduschkorb, schwarz**

Corner shower shelf, black

245×60×150mm

102308120



59,00 €

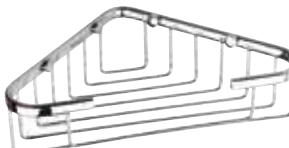

**Eckduschkorb, poliert**

Corner Shower shelf, polished

250×60×155mm

146208342



45,00 €

146102272  
poliert/polished



146102275  
matt/mat



**Duschablage**

Soap dish polished surface

270×40×110 mm

146102272

146102275



93,00 €

93,00 €

**Duschkorb, matt**

Shower shelf, mat

230×30×100 mm

102308070



63,00 €



**Duschkorb, matt**

Soap basket, mat

230×30×120 mm

104308072



45,00 €



**Duschkorb, poliert**

Shower shelf, polished

230×30×100 mm

102308072



45,00 €

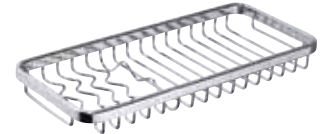

**Duschkorb, poliert**

Shower shelf, polished

300×30×130 mm

102308082



52,00 €



**Duschkorb, poliert**

Shower shelf, polished

200×30×115 mm

102308112



45,00 €



**Seifenschale, stehend**

Shower shelf, polished

95×30×75 mm

104708182



16,00 €



**Duschregal, poliert**

Shower basket double, polished

220×320×116 mm

146208182



118,00 €



**Zweistöckiger Duschkorb, poliert**

Shower basket double, polished

305×380×115 mm

102308241



182,00 €



**Zweistöckiges Duschregal zum Einhängen, poliert**

Double hanging shower shelf, polished

250×705×205 mm

146208422

197,00 €



**Duschkorb zum Einhängen, poliert**

Hanging shower shelf, polished

250×455×160 mm

146208432

120,00 €



**Zweistöckiger Eckduschregal, poliert**

Double soap basket, corner model, polished

355×375×240 mm

146208222



247,00 €



**Zweistöckiger Eckduschregal, poliert**

Double soap basket, corner model, polished

340×365×205 mm

146208202



204,00 €



**Zweistöckiges Eckduschregal, poliert**

Double soap basket, corner model, polished

260×325×155 mm

102308132



104,00 €



**Zweistöckiges Eckduschregal, poliert**

Double soap basket, corner model, polished

220×500×205 mm

146208232



159,00 €

# rawell



material  
material

### Kleiderhaken magnetisch

Magnetic single robe hook

54×54×57 mm

104106182

41,00 €

### Doppelkleiderhaken magnetisch

Magnetic double robe hook

84×60×66 mm

104206182

46,00 €

### Handtuchhalter gebogen für Heizkörper, poliert

Towel holder for radiator, polished

600×80×220 mm

134504232

55,00 €

### Handtuchhalter gebogen für Heizkörper, weiß

Towel holder for radiator, white

600×80×220 mm

134504235

38,00 €

Edelstahl  
stainless steel



Oberflächenfinish  
Surface finish

### Handtuchhalter magnetisch

Magnetic towel holder

260×54×63 mm

104104262

81,00 €

### Handtuchhalter magnetisch

Magnetic towel holder

430×54×63 mm

104104272

83,00 €

### Handtuchhalter magnetisch

Magnetic towel holder

550×54×63 mm

104104282

86,00 €

Chrom  
chrome



poliert  
polished



komaxit  
comaxit



weiß Lack  
black lacquer

### Heizkörperhaken

Radiator hook

32×32×80 mm

104506122 poliert/polished

23,00 €

104506124 weiß/white

26,00 €

### Handtuchhalter für Heizkörper mit Haken, poliert

Radiator adjustable towel holder with hooks, polished

355×40×90 mm

134504222

57,00 €

### Handtuchhalter für Heizkörper mit Haken, weiß

Radiator adjustable towel holder with hooks, white

355×40×90 mm

134504225

59,00 €

### Einfacher Handtuchhalter für Heizkörper, poliert

Radiator towel holder SINGLE, polished

610×48×140 mm

101204161

96,00 €



### Einfacher Handtuchhalter für Heizkörper, weiß

Radiator towel holder SINGLE, white

610×48×140 mm

101204164

59,00 €

### Doppelter Handtuchhalter für Heizkörper, weiß

Radiator towel holder DOUBLE, white

590×75×150 mm

101604174

60,00 €



### Handtuchhalter für Heizkörper gerade

Straight adjustable towel bar

600×40×90 mm

134504202

48,00 €

### Handtuchhalter für Heizkörper gebogen

Adjustable towel bar, for radiator

600×40×95 mm

134504212

54,00 €

# vista



**Seifenschale, stehend**

Soap dish holder, free standing

110×30×70 mm

120108196-100

21,00 €

**Seifenschale, stehend**

Soap dish holder, free standing

110×30×70 mm

120108196-101

21,00 €

**Seifenschale, stehend**

Soap dish holder, free standing

110×30×70 mm

120108196-102

21,00 €

**Seifenschale, stehend**

Soap dish holder, free standing

110×30×70 mm

120108196-104

21,00 €

material  
material

Poliresin



**Zahnbürstenbecher, stehend**

Toothbrush holder, free standing

72×110×72 mm

120111026-100

26,00 €

**Zahnbürstenbecher, stehend**

Toothbrush holder, free standing

72×110×72 mm

120111026-101

26,00 €

**Zahnbürstenbecher, stehend**

Toothbrush holder, free standing

72×110×72 mm

120111026-102

26,00 €

**Zahnbürstenbecher, stehend**

Toothbrush holder, free standing

72×110×72 mm

120111026-104

26,00 €

Oberflächenfinish  
Surface finish

klar, schwarz  
clear black



poliert  
polished

klar, beige  
clear beige



poliert  
polished

klar, blau  
clear blue



poliert  
polished

klar, weiß  
clear white



poliert  
polished



**Seifenspender, stehend**

Soap dispenser, free standing

70×172×82 mm, 250 ml

120109016-100

36,00 €

**Seifenspender, stehend**

Soap dispenser, free standing

70×172×82 mm, 250 ml

120109016-101

36,00 €

**Seifenspender, stehend**

Soap dispenser, free standing

70×172×82 mm, 250 ml

120109016-102

36,00 €

**Seifenspender, stehend**

Soap dispenser, free standing

70×172×82 mm, 250 ml

120109016-104

36,00 €



**WC-Bürstengarnitur, stehend**

Toilet standing brush, free standing

100×370×100 mm

120113316-100

56,00 €

**WC-Bürstengarnitur, stehend**

Toilet standing brush, free standing

100×370×100 mm

120113316-101

56,00 €

**WC-Bürstengarnitur, stehend**

Toilet standing brush, free standing

100×370×100 mm

120113316-102

56,00 €

**WC-Bürstengarnitur, stehend**

Toilet standing brush, free standing

100×370×100 mm

120113316-104

56,00 €

# HANDTUCHWÄRMER

HEATED TOWEL RAILS



**Elektrisch beheizter Handtuchhalter**  
 Heated towel rail  
 185×1180×120 mm, 91 W  
 704153110 schwarz/black 579,00 €  
 704153111 poliert/polished 497,00 €



**Elektrisch beheizter Handtuchhalter**  
 Heated towel rail  
 125×1180×120 mm, 61 W  
 704153120 schwarz/black 456,00 €  
 704153121 poliert/polished 410,00 €



**Elektrisch beheizter Handtuchhalter**  
 Heated towel rail  
 125×1180×155 mm, 47 W  
 704153130 schwarz/black 374,00 €  
 704153131 poliert/polished 337,00 €

material  
material

Edelstahl  
stainless  
steel

Oberflächenfinish  
Surface finish

Chrom  
chrome

poliert  
polished

komaxit  
comaxit

weiß  
white

schwarz  
black  
lacquer

schwarz  
black  
lacquer



**Elektrisch beheizter Handtuchhalter, schwarz**  
 Heated towel rail, black  
 450×960×110 mm, 130 W  
 704151040 319,00 €



**Elektrisch beheizter Handtuchhalter, poliert**  
 Heated towel rail, black, polished  
 450×960×110 mm, 130 W  
 704151041 343,00 €



**Elektrisch beheizter Handtuchhalter, weiß**  
 Heated towel rail, black, polished, white  
 450×960×110 mm, 130 W  
 704151044 319,00 €



**Elektrisch beheizter Handtuchhalter, schwarz**  
 Heated towel rail, black  
 450×1 320×110 mm, 180 W  
 704151050 414,00 €



**Elektrisch beheizter Handtuchhalter, poliert**  
 Heated towel rail, black, polished  
 450×1 320×110 mm, 180 W  
 704151051 449,00 €



**Elektrisch beheizter Handtuchhalter, weiß**  
 Heated towel rail, black, polished, white  
 450×1 320×110 mm, 180 W  
 704151054 414,00 €



**Elektrisch beheizter Handtuchhalter, schwarz**  
 Heated towel rail, black  
 600×1 680×110 mm, 285 W  
 704151060 505,00 €



**Elektrisch beheizter Handtuchhalter, poliert**  
 Heated towel rail, black, polished  
 600×1 680×110 mm, 285 W  
 704151061 541,00 €



**Elektrisch beheizter Handtuchhalter, weiß**  
 Heated towel rail, black, polished, white  
 600×1 680×110 mm, 285 W  
 704151064 505,00 €



**Elektrisch beheizter Handtuchhalter, Stange, schwarz**  
 Heated towel rail, rod, black  
 124×1 720×155 mm, 46 W  
 704151000 247,00 €



**Elektrisch beheizter Handtuchhalter, Stange, poliert**  
 Heated towel rail, rod, polished  
 124×1 720×155 mm, 46 W  
 704151001 243,00 €



**Elektrisch beheizter Handtuchhalter, Stange, weiß**  
 Heated towel rail, rod, white  
 124×1 720×155 mm, 46 W  
 704151004 247,00 €



schwarz matt/black matt

**Elektrischer Handtuchwärmer, mini**

Electric towel rail, mini ladder  
560×370×90 mm, 63 W



704151080

342,00 €



silber poliert/silver polished

**Elektrischer Handtuchwärmer, mini**

Electric towel rail, mini ladder  
560×370×90 mm, 63 W



704151081

342,00 €

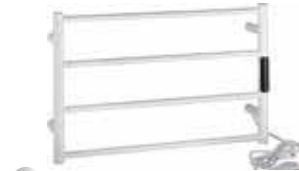

weiß matt/white matt

**Elektrischer Handtuchwärmer, mini**

Electric towel rail, mini ladder  
560×370×90 mm, 63 W



704151084

342,00 €



gold poliert/gold polished

**Elektrischer Handtuchwärmer, mini**

Electric towel rail, mini ladder  
560×370×90 mm, 63 W



704153081

399,00 €



gold matt/gold matt

**Elektrischer Handtuchwärmer, mini**

Electric towel rail, mini ladder  
560×370×90 mm, 63 W



704153085

399,00 €



gold kupfer poliert/gold copper polished

**Elektrischer Handtuchwärmer, mini**

Electric towel rail, mini ladder  
560×370×90 mm, 63 W



704154081

399,00 €



gold kupfer matt/gold copper matt

**Elektrischer Handtuchwärmer, mini**

Electric towel rail, mini ladder  
560×370×90 mm, 63 W



704154085

399,00 €



graphit matt/graphite matt

**Elektrischer Handtuchwärmer, mini**

Electric towel rail, mini ladder  
560×370×90 mm, 63 W



704155085

399,00 €

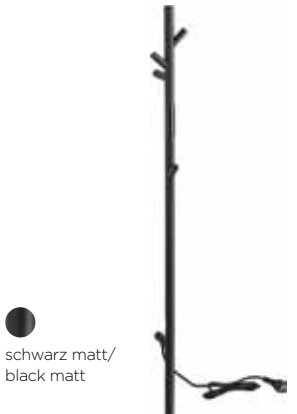

schwarz matt/  
black matt

**Elektrischer Handtuchwärmer, Stange, mini**

Electric towel rail, bar, mini  
103×1180×90 mm, 30 W



704151010

285,00 €



silber poliert/  
silver polished

**Elektrischer Handtuchwärmer, Stange, mini**

Electric towel rail, bar, mini  
103×1180×90 mm, 30 W



704151011

285,00 €



weiß matt/  
white matt

**Elektrischer Handtuchwärmer, Stange, mini**

Electric towel rail, bar, mini  
103×1180×90 mm, 30 W



704151014

285,00 €



gold poliert/  
gold polished

**Elektrischer Handtuchwärmer, Stange, mini**

Electric towel rail, bar, mini  
103×1180×90 mm, 30 W



704153011

342,00 €



gold matt/  
gold matt

**Elektrischer Handtuchwärmer, Stange, mini**

Electric towel rail, bar, mini  
103×1180×90 mm, 30 W



704153015

342,00 €



gold kupfer poliert/  
gold copper polished

**Elektrischer Handtuchwärmer, Stange, mini**

Electric towel rail, bar, mini  
103×1180×90 mm, 30 W



704154011

342,00 €



gold kupfer matt/  
gold copper matt

**Elektrischer Handtuchwärmer, Stange, mini**

Electric towel rail, bar, mini  
103×1180×90 mm, 30 W



704154015

342,00 €



graphit matt/  
graphite matt

**Elektrischer Handtuchwärmer, Stange, mini**

Electric towel rail, bar, mini  
103×1180×90 mm, 30 W



704155015

342,00 €



● schwarz matt/black matt

**Aufhänger für elektrischen Handtuchhalter 704151010**

Hanger for electric towel rail 704151010

450×122×98 mm

704151910

34,00 €



● silber poliert/silver polished

**Aufhänger für elektrischen Handtuchhalter 704151011**

Hanger for electric towel rail 704151011

450×122×98 mm

704151911

34,00 €



● weiß matt/white matt

**Aufhänger für elektrischen Handtuchhalter 704151014**

Hanger for electric towel rail 704151014

450×122×98 mm

704151914

34,00 €



● gold poliert/gold polished

**Aufhänger für elektrischen Handtuchhalter 704153011**

Hanger for electric towel rail 704153011

450×122×98 mm

704153911

45,00 €



● gold matt/gold matt

**Aufhänger für elektrischen Handtuchhalter 704153015**

Hanger for electric towel rail 704153015

450×122×98 mm

704153915

45,00 €



● gold kupfer poliert/gold copper polished

**Aufhänger für elektrischen Handtuchhalter 704154011**

Hanger for electric towel rail 704154011

450×122×98 mm

704154911

45,00 €



● gold kupfer matt/gold copper matt

**Aufhänger für elektrischen Handtuchhalter 704154015**

Hanger for electric towel rail 704154015

450×122×98 mm

704154915

45,00 €



● graphit matt/graphite matt

**Aufhänger für elektrischen Handtuchhalter 704155015**

Hanger for electric towel rail 704155015

450×122×98 mm

704155915

45,00 €



● schwarz matt/black matt

**Adapter zum verdeckten Anschluss elektrischer Wäschetrockner an die Wand**

Concealed connection kit for electric towel rails

64×64×74 mm

131567814

28,00 €



● silber poliert/silver polished

**Adapter zum verdeckten Anschluss elektrischer Wäschetrockner an die Wand**

Concealed connection kit for electric towel rails

64×64×74 mm

131567813

28,00 €



● weiß matt/white matt

**Adapter zum verdeckten Anschluss elektrischer Wäschetrockner an die Wand**

Concealed connection kit for electric towel rails

64×64×74 mm

131567815

28,00 €



● gold poliert/gold polished

**Adapter zum verdeckten Anschluss elektrischer Wäschetrockner an die Wand**

Concealed connection kit for electric towel rails

64×64×74 mm

131567816

32,00 €



● gold matt/gold matt

**Adapter zum verdeckten Anschluss elektrischer Wäschetrockner an die Wand**

Concealed connection kit for electric towel rails

64×64×74 mm

131567817

29,00 €



● gold kupfer poliert/gold copper polished

**Adapter zum verdeckten Anschluss elektrischer Wäschetrockner an die Wand**

Concealed connection kit for electric towel rails

64×64×74 mm

131567818

32,00 €



● gold kupfer matt/gold copper matt

**Adapter zum verdeckten Anschluss elektrischer Wäschetrockner an die Wand**

Concealed connection kit for electric towel rails

64×64×74 mm

131567819

29,00 €



● graphit matt/graphite matt

**Adapter zum verdeckten Anschluss elektrischer Wäschetrockner an die Wand**

Concealed connection kit for electric towel rails

64×64×74 mm

131567820

32,00 €

# DUSCHRINNEN

SHOWER DRAINS



## Duschrinne PLUS

Shower drain PLUS

254653011 L = 500	118,00 €
254653021 L = 600	127,00 €
254653031 L = 700	137,00 €
254653041 L = 800	147,00 €
254653051 L = 900	158,00 €
254653061 L = 1000	169,00 €

INOXS



KARE



LINE



## Duschrinne

Shower drain

254653111 L = 500	81,00 €
254653121 L = 600	88,00 €
254653131 L = 700	95,00 €
254653141 L = 800	104,00 €
254653151 L = 900	109,00 €
254653161 L = 1000	117,00 €

INOXS



KARE



LINE



## Duschrinne an der Wand

Shower drain to the wall

254653231 L = 700	125,00 €
254653241 L = 800	136,00 €
254653251 L = 900	146,00 €

INOXS



KARE



LINE



matt  
material

Edelstahl  
stainless  
steel

Kunststoff  
plastic

Oberflächenfinish  
Surface finish

matt  
matt

## Rost aus Edelstahl

254653011, 254653311

Grate for shower drain 254653011, 254653111

L = 500 mm

254657815 INOKS	36,00 €
254657015 KARE	36,00 €
254657415 LINE	36,00 €

## Rost aus Edelstahl

254653121, 254653021

Grate for shower drain 254653021, 254653121

L = 600 mm

254657825 INOKS	38,00 €
254657025 KARE	38,00 €
254657425 LINE	38,00 €

## Rost aus Edelstahl

254653131, 254653031, 254653231

Grate for shower drain 254653031, 254653131, 254653231

L = 700 mm

254657835 INOKS	40,00 €
254657035 KARE	40,00 €
254657435 LINE	40,00 €

## Rost aus Edelstahl

254653141, 254653041, 254653241

Grate for shower drain 254653141, 254653041, 254653241

L = 800 mm

254657845 INOKS	43,00 €
254657045 KARE	43,00 €
254657445 LINE	43,00 €

## Rost aus Edelstahl

254653151, 254653051, 254653251

Grate for shower drain 254653151, 254653051, 254653251

L = 900 mm

254657855 INOKS	47,00 €
254657055 KARE	47,00 €
254657455 LINE	47,00 €

## Rost aus Edelstahl

254653161, 254653061

Grate for shower drain 254653161, 254653061

L = 1000 mm

254657865 INOKS	52,00 €
254657065 KARE	52,00 €
254657465 LINE	52,00 €

## INOXS-Gitter nach Maß

Doppelseitiges INOKS-Gitter – eine Seite komplett aus Edelstahl, auf der anderen Seite Möglichkeit zum Einlegen eigener Fliesen bis zu 13 mm Dicke.

## Custom design of INOKS grid

Double-sided INOKS grid – full stainless steel on one side, on the other side, possibility of inserting your own tiles up to 13 mm thick.



## Ablauf-Sieb für Siphon

254653926 und 254653916

Drain strainer for siphon 254653926 and 254653916

131×57×208 mm

254653995

3,50 €

## Siphon für Duschrinne ø 40 mm

Siphon for shower drain ø 40 mm

131×47×208 mm

254653926

26,00 €

## Siphon für Duschrinne ø 50 mm

Siphon for shower drain ø 50 mm

131×57×208 mm

254653916

26,00 €



# KOSMETIKSPIEGEL UND SPIEGEL

BATHROOM MIRRORS

<p>material material</p> <p>Messing brass</p>	 <p>5x LED IP44</p> <p><b>Kosmetikspiegel mit 3x LED-Beleuchtung</b> Cosmetic mirror with 3x LED lighting 230x200x405 mm, ø 200 mm</p> <p>155101140 <span style="float: right;">558,00 €</span></p>	 <p>5x LED IP44</p> <p><b>Kosmetikspiegel mit 3x LED-Beleuchtung</b> Cosmetic mirror with 3x LED lighting 230x200x405 mm, ø 200 mm</p> <p>170101149 <span style="float: right;">558,00 €</span></p>	 <p>7x LED IP44</p> <p><b>Kosmetikspiegel mit 3x LED-Beleuchtung</b> Cosmetic mirror with 3x LED lighting 255x200x400 mm, ø 200 mm</p> <p>112101779 <span style="float: right;">305,00 €</span></p>
<p>Edelstahl stainless steel</p> <p>Kunststoff plastic</p> <p>Spiegel mirror</p> <p>Oberflächenfinish Surface finish</p> <p>Chrom chrome</p>	 <p>3x LED IP44</p> <p><b>Kosmetikspiegel mit 2x LED-Beleuchtung</b> Cosmetic mirror with 2x LED lighting 240x240x390 mm, ø 240 mm</p> <p>116401772 <span style="float: right;">315,00 €</span></p>	 <p>3x LED IP21</p> <p><b>Kosmetikspiegel mit 2x LED-Beleuchtung</b> Cosmetic mirror with 2x LED lighting 220x200x370 mm, ø 200 mm</p> <p>116301142 <span style="float: right;">261,00 €</span></p>	 <p>3x LED IP44</p> <p><b>Kosmetikspiegel mit 2x LED-Beleuchtung</b> Cosmetic mirror with 2x LED lighting 225x200x365 mm, ø 200 mm</p> <p>116101770 <span style="float: right;">261,00 €</span></p>
<p>poliert polished</p> <p>matt matt</p>	 <p>3x LED IP44</p> <p><b>Kosmetikspiegel mit 2x LED-Beleuchtung</b> Cosmetic mirror with 2x LED light 230x210x400 mm, ø 210 mm</p> <p>116101802 <span style="float: right;">289,00 €</span></p>	 <p>5x LED IP44</p> <p><b>Kosmetikspiegel mit 3x LED-Beleuchtung</b> Cosmetic mirror with 3x LED light 255x200x400 mm, ø 200 mm</p> <p>112101149 <span style="float: right;">279,00 €</span></p>	 <p>5x LED IP44</p> <p><b>Kosmetikspiegel mit 3x LED-Beleuchtung</b> Cosmetic mirror with 3x LED lighting 255x200x400 mm, ø 200 mm</p> <p>112101140 <span style="float: right;">296,00 €</span></p>
<p>poliert polished</p>	 <p>3x LED IP44</p> <p><b>Kosmetikspiegel mit 2x LED-Beleuchtung</b> Cosmetic mirror with 2x LED lighting 335x200x280 mm, ø 200 mm</p> <p>116201772 <span style="float: right;">289,00 €</span></p>	 <p>3x LED IP44</p> <p><b>Kosmetikspiegel mit 2x LED-Beleuchtung</b> Cosmetic mirror with 2x LED light 225x200x365 mm, ø 200 mm</p> <p>116101772 <span style="float: right;">261,00 €</span></p>	 <p>5x LED IP44</p> <p><b>Kosmetikspiegel mit 3x LED-Beleuchtung</b> Cosmetic mirror with 3x LED lighting 255x200x400 mm, ø 200 mm</p> <p>112101144 <span style="float: right;">296,00 €</span></p>
<p>poliert polished</p>	 <p>3x LED IP44</p> <p><b>Kosmetikspiegel mit 2x LED-Beleuchtung</b> Cosmetic mirror with 3x LED lighting 220x200x365 mm, ø 200 mm</p> <p>116101142 <span style="float: right;">261,00 €</span></p>	 <p>5x U</p> <p><b>Kosmetikspiegel mit 2x LED-Beleuchtung aufklebbar, magnetisch</b> Glue-on mirror with 3x LED lighting 151x151x17 mm, ø 131 mm</p> <p>112101150 <span style="float: right;">69,00 €</span></p>	 <p>1x + 3x</p> <p><b>Kosmetikspiegel</b> Cosmetic mirror 185x280x420 mm, ø 135 mm</p> <p>106301122 <span style="float: right;">51,00 €</span></p>

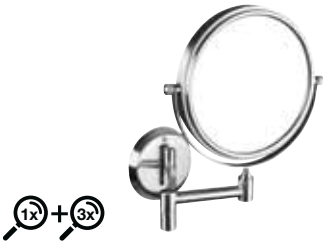

**Kosmetikspiegel**

Double-sided cosmetic mirror  
184×200×412 mm, ø 133 mm

106301705

Gebürsteteoberfläche/brushed surface



116,00 €



**Kosmetikspiegel**

Double-sided cosmetic mirror  
180×250×360 mm, ø 133 mm

106101697

Bronzeoberfläche/bronze surface



116,00 €

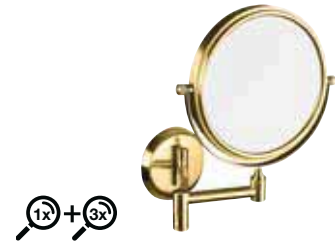

**Kosmetikspiegel**

Double-sided cosmetic mirror  
180×250×360 mm, ø 133 mm

106101698

Goldeneoberfläche/gold surface



116,00 €



**Doppelseitiger Kosmetikspiegel**

Double-sided cosmetic mirror  
230×300×430 mm, ø 200 mm

172201512



63,00 €



**Doppelseitiger Kosmetikspiegel**

Double-sided cosmetic mirror  
230×280×345 mm, ø 200 mm

172201522



60,00 €

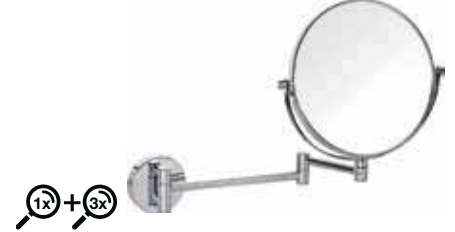

**Kosmetikspiegel**

Double-sided cosmetic mirror  
230×280×430 mm, ø 180 mm

112201512



102,00 €



**Kosmetikspiegel**

Cosmetic mirror  
230×280×430 mm, ø 180 mm

112201514 weiß/white

112201510 schwarz/black



132,00 €



**Doppelseitiger Kosmetikspiegel**

Double-sided cosmetic mirror  
230×300×430 mm, ø 200 mm

172201510



69,00 €



**Kosmetikspiegel**

Cosmetic mirror  
215×215×418 mm, ø 203 mm

116301522



172,00 €



**Kosmetikspiegel**

Cosmetic mirror  
200×240×117 mm, ø 200 mm

112201332



77,00 €

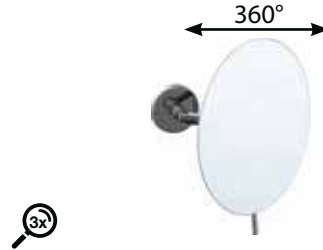

**Kosmetikspiegel**

Cosmetic mirror  
200×240×130 mm, ø 200 mm

116201332



100,00 €



**Kosmetikspiegel**

Cosmetic mirror  
238×255×465 mm, ø 182 mm

112201518



123,00 €



**Kosmetikspiegel**

Cosmetic mirror  
140×140×80 mm, ø 140 mm

112101121



62,00 €



**Kosmetikspiegel**

Cosmetic mirror  
140×140×200 mm, ø 140 mm

112101521



79,00 €



**Kosmetikspiegel**

Cosmetic mirror  
232×265×365 mm, ø 180 mm

112201522



88,00 €



**Kosmetikspiegel mit 2x LED Beleuchtung**  
Cosmetic mirror with 2x LED light  
240x200x410 mm  
116101202

333,00 €



**Kosmetikspiegel mit 2x LED Beleuchtung**  
Cosmetic mirror with 2x LED lighting  
325x200x310 mm  
116201202

342,00 €



**Kosmetikspiegel, 2x LED Beleuchtung**  
Cosmetic mirror with 2x LED lighting  
280x225x470 mm  
116301812

305,00 €



**Kosmetikspiegel**  
Cosmetic mirror  
215x215x462 mm, ø 203 mm  
116301212

172,00 €



**Kosmetikspiegel**  
Cosmetic mirror  
130x240x100 mm  
112201222

77,00 €

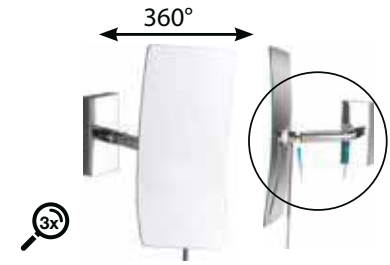

**Kosmetikspiegel**  
Cosmetic mirror  
130x245x130 mm  
116201222

100,00 €



**Kosmetikspiegel**  
Cosmetic mirror  
195x320x390 mm  
153301612

104,00 €



**Kosmetikspiegel mit 2x LED Beleuchtung**  
Cosmetic mirror on a pole with 2x LED lighting  
200x575x155 mm, ø 200 mm  
116501682

289,00 €



**Kosmetikspiegel**  
Cosmetic mirror  
200x515x120 mm, ø 200 mm  
116201792

81,00 €



**Kosmetikspiegel**  
Cosmetic mirror  
200x535x140 mm, ø 200 mm  
112201172

156,00 €



**Kosmetikspiegel mit Wandstange**  
One-sided cosmetic mirror on a pole  
200x535x140 mm  
132201172

156,00 €



**Kosmetikspiegel mit 2fach LED Beleuchtung**  
Cosmetic mirror on a pole with 2x LED lighting  
200x550x155 mm  
116501672

342,00 €



**Kosmetikspiegel eckig, stehend**  
Cosmetic standing mirror  
215x375x145 mm  
116401312

102,00 €



**Kosmetikspiegel eckig, stehend**  
Cosmetic mirror rectangular single side, free standing  
130x300x190 mm  
116201312

70,00 €



**Kosmetikspiegel teleskopisch**  
Cosmetic mirror, telescopic  
232x370x120 mm, ø 200 mm  
112201414  
112201410

97,00 €  
91,00 €



**Kosmetikspiegel rund, stehend**  
Cosmetic mirror round single side, free standing  
200×300×190 mm, ø 200 mm  
116201252

70,00 €



**Kosmetikspiegel rund, stehend**  
Cosmetic standing mirror  
215×375×145 mm, ø 215 mm  
116401412

102,00 €



**Kosmetikspiegel eckig, stehend**  
Cosmetic standing mirror  
130×300×190 mm  
116201310

84,00 €



**Doppelseitiger Kosmetikspiegel, stehend**  
Double-sided cosmetic mirror, free standing  
232×370×120 mm, ø 200 mm  
112201412

88,00 €



**Kosmetikspiegel freistehend**  
Double-sided cosmetic mirror free standing  
232×385×150 mm, ø 200 mm  
112201254

84,00 €



**Doppelseitiger Kosmetikspiegel, stehend**  
Double-sided cosmetic mirror, free standing  
235×385×150 mm, ø 200 mm  
112201252

84,00 €

**Spiegel mit LED Beleuchtung, Berührungssensor**  
Mirror with LED lighting, touch sensor

600×800×39 mm, 4,99 W 101201107	422,00 €	600×800×39 mm, 4,99 W 101301107	410,00 €	600×800×39 mm, 4,99 W 101401107	437,00 €
800×800×39 mm, 4,99 W 101201127	414,00 €	800×800×39 mm, 4,99 W 101301127	435,00 €	800×800×39 mm, 4,99 W 101401127	533,00 €
1000×600×39 mm, 4,99 W 101201137	481,00 €	1000×600×39 mm, 4,99 W 101301137	486,00 €	1000×600×39 mm, 4,99 W 101401137	487,00 €
1000×800×39 mm, 4,99 W 101201147	487,00 €	1000×800×39 mm, 4,99 W 101301147	559,00 €	1000×800×39 mm, 4,99 W 101401147	521,00 €
1200×600×39 mm, 4,99 W 101201157	520,00 €	1200×600×39 mm, 4,99 W 101301157	534,00 €	1200×600×39 mm, 4,99 W 101401157	555,00 €

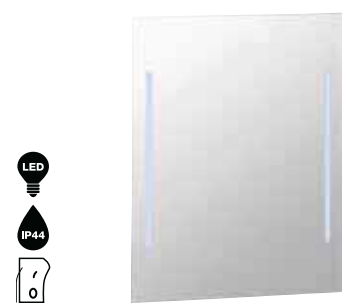

**Spiegel mit LED Beleuchtung**  
Mirror with LED lighting  
600×800×35 mm, 3 W  
127201659

338,00 €

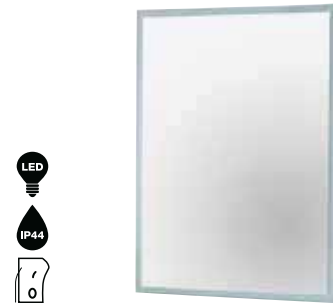

**Spiegel mit LED Beleuchtung**  
Mirror with LED lighting  
600×800×35 mm, 8 W  
127201679

419,00 €

# PUBLIC SPACES

material  
material

Messing  
brass

Edelstahl  
stainless steel

Kunststoff  
plastic

Spiegel  
mirror

Oberflächenfinish  
Surface finish

Chrom  
chrome

poliert  
polished

gebürstet  
brushed

weiß  
Lack  
white  
lacquer

schwarz  
Lack  
black  
lacquer

matt  
matt



### Automatischer Seifenspender, Kunststoff

Automatic liquid soap dispenser, plastic

140×235×107 mm, 1100 ml

124109347 Seife/soap

124109334 Desinfektion/disinfectant

120,00 €

### Automatischer Seifenspender, Edelstahl

Automatic liquid soap dispenser, stainless steel

140×235×102 mm, 1200 ml

124109265 Seife/soap

124109335 Desinfektion/disinfectant

173,00 €



### Automatischer Desinfektionsmittelspender, mit Standfuß, Kunststoff

Automatic disinfectant dispenser with stand

300×1215×300 mm, 1100 ml

124109346 256,00 €

### Automatischer Desinfektionsmittelspender, mit Standfuß, Edelstahl

Automatic disinfectant dispenser with stand, stainless steel

350×1230×350 mm, 1200 ml

124109355 468,00 €

### Automatischer Seifenspender, Kunststoff

Automatic dispenser, plastic

140×235×102 mm, 1200 ml

124109290

124109330

116,00 €

116,00 €

### Automatischer Schaumseifenspender, Kunststoff

Automatic foam soap dispenser, plastic

135×275×120 mm, 1000 ml

121209032

160,00 €



AKU + USB



### Automatischer Schaumseifenspender

Automatic foam soap dispenser

100×220×110, 700ml

141109195 182,00 €

### Automatischer Seifenspender, Edelstahl

Automatic liquid soap dispenser, stainless steel

70×175×120 mm, 250 ml

137209155 126,00 €

### Automatischer Spender, Edelstahl

Automatic soap or didinfectant gel dispenser, stainless steel, brushed

142×268×102 mm, 1100 ml

105109335 Seifen- und Desinfektion, Gel/

disinfection or soap, gel

251,00 €

### Automatischer Spender, Edelstahl

Automatic soap dispenser - foam, stainless steel

142×268×102 mm, 1100 ml

105109345 Seifen, Schaum/soap, foam

264,00 €



### Seifenspender, Kunststoff

Soap dispenser, plastic

86×165×115 mm, 450 ml

107109240 37,00 €

### Seifenspender, Edelstahl

Soap dispenser, stainless steel

86×160×105 mm, 450 ml

107109256 24,00 €

### Seifenspender, Edelstahl, gebürstet

Soap dispenser, stainless steel, brushed

120×320×175 mm, 1100 ml

105109285

200,00 €

### Seifenspender, Edelstahl

Lever dispenser for liquid soap, stainless steel

100×335×195 mm, 1000 ml

101109285

58,00 €



### Seifenspender, Edelstahl

Soap dispenser, stainless steel

100×320×110 mm, 1 100 ml

105109410 90,00 €

### Seifenspender, Edelstahl, weiß

Soap dispenser, stainless steel, white

100×320×110 mm, 1 100 ml

105109414 90,00 €

### Seifenspender, Edelstahl, poliert

Soap dispenser, stainless steel, polished

100×320×110 mm, 1 100 ml

105109411 90,00 €

### Seifenspender, Edelstahl, gebürstet

Soap dispenser, stainless steel, brushed

100×320×110 mm, 1 100 ml

105109415 90,00 €



### Automatischer Seifenspender, Kunststoff

Automatic dispenser, plastic

138×230×103 mm, 1200 ml

124109426 Seife/soap 47,00 €

124109436 Schaum/foam 47,00 €



### Seifenspender, Kunststoff

Soap dispenser, plastic

115×245×110 mm, 1000 ml

121209037 Seife/soap 63,00 €

121209407 Schaum/foam 60,00 €



### Seifenspender, Kunststoff

Soap dispenser, plastic

115×245×110 mm, 1000 ml

121209030 Seife/soap 60,00 €

121209400 Schaum/foam 60,00 €



### Seifenspender, Kunststoff

Soap dispenser, plastic

115×245×110 mm, 1000 ml

121109036 Seife/soap 58,00 €

121109406 Schaum/foam 55,00 €



### Seifenspender, Kunststoff

Soap dispenser, plastic

65×185×75 mm, 300 ml

121209142 poliert/polished 38,00 €

121209145 gebürstet/matt 38,00 €



### Doppelseifenspender, Kunststoff

Double soap dispenser, plastic

120×185×75 mm, 2×300 ml

121209132 poliert/polished 67,00 €

121209135 gebürstet/matt 60,00 €



### Seifenspender, Kunststoff

Soap dispenser, plastic

65×185×75 mm, 300 ml

121209144 32,00 €



### Seifenspender, Kunststoff

Soap dispenser, plastic

65×185×75 mm, 300 ml

121209140 schwarz/black 36,00 €



### Seifenspender, Edelstahl, gebürstet

Soap dispenser, stainless steel, matt

125×240×100, 350 ml

151109015 86,00 €



### Seifenspender, Kunststoff, gebürstet

Soap dispenser, plastic

125×240×100 mm, 500 ml

151109095 48,00 €



### Seifenspender, Edelstahl

Soap dispenser, stainless steel

110×240×85 mm, 800 ml

106109085 85,00 €



### Seifenspender

Soap dispenser

123×336×115 mm, 1 100 ml

101009415 219,00 €



### Seifenspender, Edelstahl, weiß

Soap dispenser, stainless steel, white

97×150×93 mm, 500 ml

105109024 78,00 €



### Seifenspender, Edelstahl

Soap dispenser, stainless steel

97×150×93 mm, 500 ml

105109025 53,00 €



### Seifenspender, Edelstahl

Soap dispenser, stainless steel

97×150×93 mm, 500 ml

105109020 80,00 €



### Seifenspender, Edelstahl poliert

Soap dispenser, brushed, stainless steel polished

100×150×105 mm, 500 ml

106109091 58,00 €



### Seifenspender, Edelstahl

Soap dispenser, stainless steel brushed

107×180×98 mm, 850 ml

105109035 58,00 €



### Seifenspender, Edelstahl

Soap dispenser, brushed, stainless steel brushed

125×210×110 mm, 1250 ml

105109075 69,00 €



### Seifenspender, Edelstahl

Soap dispenser, brushed, stainless steel brushed

180×180×105 mm, 1500 ml

105109205 89,00 €



### Einbauseifenspender, Edelstahl

Integrated soap dispenser, stainless steel

240×140×150 mm, 1100 ml

105109015 184,00 €



**Halter für Seifenspender, rund**

Holder for soap dispenser, round

90×175×70, 500 ml

146109420 schwarz/black

146109421 poliert/polished

146109425 gebürstet/brushed



59,00 €

59,00 €

56,00 €



**Doppelhalter für Seifenspender, rund**

Double holder for soap dispenser, round

150×175×70, 2×500 ml

146109430 schwarz/black

146109431 poliert/polished

146109435 gebürstet/brushed



75,00 €

75,00 €

71,00 €



**Dreifachhalter für Seifenspender, rund**

Triple holder for soap dispenser, round

227×175×70, 3×500 ml

146109440 schwarz/black

146109441 poliert/polished

146109445 gebürstet/brushed



102,00 €

102,00 €

97,00 €



**Kunststoffflasche mit Pumpe für Seifenspender, rund**

plastic bottle with pump for soap dispenser, round

75×205×75, 500 ml

131567700 weiß/white

131567701 braun/brown

131567702 schwarz/black



5,00 €

5,00 €

5,00 €



Holders and bottles are combined according to the customer's choice.  
Halter und Flaschen werden nach Kundenwunsch kombiniert.



**Der Magnetschlüssel ist Bestandteil der Verpackung.**  
The magnetic key is part of packaging.

131567709



**Flaschenverschluss für Seifenspender**

Bottle cap for soap dispenser

30×17×30 mm

131567719 weiß/white

131567708 schwarz/black



1,00 €



**Halter für Seifenspender, eckig**

Holder for soap dispenser, square

80×185×60, 2×500 ml

146109450 schwarz/black

146109451 poliert/polished

146109455 gebürstet/brushed



59,00 €

59,00 €

56,00 €



**Doppelhalter für Seifenspender, eckig**

Double holder for soap dispenser, square

132×185×55, 2×500 ml

146109460 schwarz/black

146109461 poliert/polished

146109465 gebürstet/brushed



75,00 €

75,00 €

71,00 €



**Dreifachhalter für Seifenspender, eckig**

Triple holder for soap dispenser, square

200×185×55, 3×500 ml

146109470 schwarz/black

146109471 poliert/polished

146109475 gebürstet/brushed



102,00 €

102,00 €

97,00 €



**Kunststoffflasche mit Pumpe für Seifenspender, eckig**

Square transparent plastic bottle with pump for soap dispenser

68×220×50, 500 ml

131567703 weiß/white

131567704 braun/brown

131567705 schwarz/black



5,00 €

5,00 €

5,00 €

**Einbaseifenspender**

Integrated soap dispenser, top filling, polished

62×287×125 mm, 470 ml

136109012 poliert/polished

136109010 gebürstet/matt

61,00 €

60,00 €

**Einbaseifen-/  
Desinfektionsmittelspender**

Built-in soap and detergent dispenser, top filling

55×270×125 mm, 300 ml

152109122 poliert/polished

152109125 gebürstet/matt

68,00 €

68,00 €

**Einbaseifen-/  
Desinfektionsmittelspender**

Built-in soap/detergent dispenser, top filling filling

48×340×120 mm, 1100 ml

152109142 poliert/polished

152109143 gebürstet/matt

68,00 €

78,00 €

**Damenbindenspender,  
Edelstahl, gebürstet**

Pad dispenser, stainless steel, brushed

144×368×95 mm

101403285

237,00 €

**Damenbindenspender,  
Edelstahl, weiß**

Pad dispenser, stainless steel, white

144×368×95 mm

101403288

245,00 €

**Damenbindenspender,  
Edelstahl, rosa**

Pad dispenser, stainless steel, pink

144×368×95 mm

101403287

245,00 €

**Spender für Tampons und  
Binden, Edelstahl, gebürstet**Tampon and pad dispenser,  
stainless steel, brushed

220×226×95 mm

101403275

229,00 €

**Spender für Tampons und  
Binden, Edelstahl, schwarz**Tampon and pad dispenser,  
stainless steel, black

220×226×95 mm

101403276

266,00 €

**Spender für Tampons und  
Binden, Edelstahl, weiß**Tampon and pad dispenser,  
stainless steel, white

220×226×95 mm

101403278

266,00 €

**Spender für Tampons und  
Binden, Edelstahl, rosa**Tampon and pad dispenser,  
stainless steel, pink

220×226×95 mm

101403277

266,00 €

**Spender für Tampons und  
Binden, Edelstahl, grün**Tampon and pad dispenser,  
stainless steel, green

220×226×95 mm

101403279

266,00 €

**Papiertuchspender,  
Kunststoff**

Paper tissue dispenser, chrome/plastic

267×72×137 mm

101303001

82,00 €

**Papiertuchspender, Edelstahl**

Paper tissue dispenser, stainless steel

250×130×75 mm

102303021 poliert/polished

102303025 gebürstet/matt

54,00 €

54,00 €

**Papiertuchbehälter**

Paper tissue dispenser

120×130×120 mm

101003021 chromed plast/chrome plastic

44,00 €

125×130×130 mm

105103071 Edelstahl/stainless steel

69,00 €

**Einbau-Papiertuchspender,  
Edelstahl**

Paper tissue dispenser, stainless steel

300×160×60 mm

113103021

85,00 €

**Papiertuchspender**

Paper tissue dispensers

273×123×78 mm

101003025

106,00 €

**Einbau-Papier-  
tuchspender, poliert**

Integrated paper tissue dispenser, polished,

200×120×110 mm

134203022

56,00 €

**Handschuhspender**

Disposable gloves dispenser

252×138×88 mm

101003215

55,00 €



**Hygienebeutelspender (HygBag), Kunststoff**

Hygiene bag dispenser (HygBag), plastic  
**100×135×25 mm**  
 chromed plastic/chrome plastic  
 10140302 17,00 €  
 schwarz, matt, plastic/black mat, plastic  
 10140303 17,00 €

**Hygienebeutelspender (HygBag), Edelstahl**

HygBag for paper bag, stainless steel  
**120×240×32 mm**  
 101403091 poliert/polished 50,00 €  
 101403095 gebürstet/matt 51,00 €  
 101403094 weiß/white 41,00 €

**Hygienebeutelspender (HygBag) für die PVC-Beutel, Edelstahl**

Hygiene bag dispenser (HygBag), stainless steel  
**92×131×24 mm**  
 101403130 schwarz/black 27,00 €  
 101403131 poliert/polished 40,00 €  
 101403135 weiß/white 40,00 €  
 101403134 gebürstet/matt 28,00 €

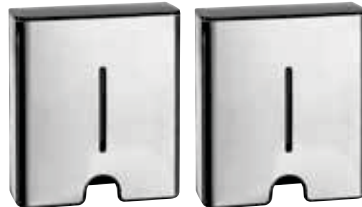

**Hygienebeutelspender (HygBag), Edelstahl**

Hygiene bag dispenser (HygBag) stainless steel  
**95×145×30 mm**  
 101403031 poliert/polished 63,00 €  
 101403035 gebürstet/matt 63,00 €

**Paperhandtuchspender, Edelstahl**

Paper towel dispenser, stainless steel  
**300×360×105 mm**  
 124103045 brus./brushed 170,00 €  
 124103043 geprägt/embossed 180,00 €

**Papierhandtuchspender**

Paper towel dispenser  
**265×192×120 mm**  
 101003045 146,00 €



**Paperhandtuchspender, Edelstahl**

Hand towel dispenser, stainless steel  
**280×245×105 mm**  
 113103030 schwarz/black 104,00 €  
 113103034 weiß/white 104,00 €  
 113103031 poliert/polished 79,00 €  
 113103035 gebürstet/matt 79,00 €

**Paperhandtuchspender, Edelstahl**

Hand towel dispenser, stainless steel  
**280×350×105 mm**  
 113103031 schwarz/black 79,00 €  
 113103044 weiß/white 112,00 €  
 113103041 poliert/polished 91,00 €  
 113103045 gebürstet/matt 91,00 €



**Papierhandtuchspender mit Seifenspender**

Paper towel dispenser with soap dispenser  
**384×336×115 mm, 1 100 ml**  
 101003205 320,00 €

**Papierhandtuchspender oben offen**

Paper towel dispenser open  
**280×213×103 mm**  
 101003235 96,00 €  
**280×360×103 mm**  
 101003275 123,00 €

**Papierhandtuchspender**

Paper towel dispenser  
**298×448×124 mm**  
 101003245 221,00 €



**Papierhandtuchspender mit Abfalleimer, wandhängend, Edelstahl**

Hand towel dispenser with garbage bin, wall mounted  
**310×1225×155 mm**  
 113103052 poliert/polished 1 318,00 €  
 113103055 gebürstet/brushed 1 318,00 €

**Papierhandtuchspender**

Paper towel dispenser  
**298×448×124 mm**  
 101003255 309,00 €

**Spiegelschrank mit Papierhandtuch- u. Seifenspender**

A mirror cabinet with a dispenser for paper towels and liquid soap  
**400×455×140 mm**  
 101003265 478,00 €

**Papierhandtuchspender mit Abfalleimer, wandhängend, Edelstahl**

Paper towel dispenser with waste bin, stainless steel, brushed  
**300×750×155 mm, 30 l**  
 105103055 900,00 €

**Papiertuchspender, Kunststoff weiß**

Paper towel dispenser, white plastic

260×315×105 mm

121103014



44,00 €

**Tuchspender für V-gefaltetes Papier**

V-folded paper towel dispenser,

white plastic

260×380×160 mm

121103106



59,00 €

**Papierauflegespender für WC-Sitz**

Toilet seat cover dispenser, white

435×285×50 mm

121103126 weiß/white



31,00 €

**JUMBO Papierrollenspender, Kunststoff weiß**

Jumbo-roll Toilet Dispenser, plastic, white

270×285×130 mm

121112056



46,00 €

**JUMBO Papierrollenspender, Kunststoff, weiß**

Jumbo-roll toilet paper dispenser, plastic, white

291×293×118 mm

124112056



38,00 €

**Papierrollenspender, Edelstahl, gebürstet**

Jumbo-roll toilet paper dispenser, stainless steel, brushed

350×350×145 mm

124112065



190,00 €

**Papierrollenspender, Edelstahl, geprägt**

Jumbo-roll toilet paper dispenser, stainless steel, embossed

350×350×145 mm

124112063



210,00 €

**JUMBO Papierrollenspender, Edelstahl**

Jumbo-roll toilet paper dispenser, stainless steel

200×210×130 mm

148112050 schwarz/black

148112054 weiß/white

148112051 poliert/polished

148112055 gebürstet/matt



72,00 €

77,00 €

56,00 €

56,00 €

**JUMBO Papierrollenspender, Edelstahl**

Jumbo-roll toilet paper dispenser, stainless steel

260×270×117 mm

148212050 schwarz/black

148212051 poliert/polished

148212055 gebürstet/matt



106,00 €

77,00 €

77,00 €

**JUMBO Papierrollenspender, Edelstahl**

Jumbo-roll toilet paper dispenser, stainless steel

310×325×128 mm

148312080 schwarz/black

148312081 poliert/polished

148312085 gebürstet/matt



147,00 €

98,00 €

98,00 €

**Spender für feuchtes Toilettenpapier**

Dispenser for wet toilet paper

173×78×145 mm

101003225



94,00 €

**Toilettenpapierspender für 7 Rollen**

Toilet paper dispenser (7 pcs)

130×679×120 mm

101003165



94,00 €

**Toilettenpapierhalter mit Ablagebox**

Toilet paper holder with cabinet

205×135×147 mm

101012175



145,00 €

**Toilettenpapierhalter**

Toilet paper holder

143×111×90 mm

101012015



55,00 €

**Doppelpapierrollenhalter mit Deckel**

Double toilet paper holder

243×111×90 mm

101012185



69,00 €

**Toilettenpapierhalter mit Handy-Ablage**

Toilet paper holder with cover/mobile phone shelf

133×67×105 mm

146212011



36,00 €

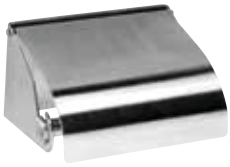

**Toilettenpapierhalter mit Deckel**

Toilet paper holder with cover  
140×80/190×100 mm  
105112315



31,00 €



**Toilettenpapierhalter**

Toilet paper holder  
180×77×93 mm  
153312132



35,00 €



**Toilettenpapierhalter mit Ablage**

Toilet paper holder with shelf  
160×100×86 mm  
101012150 schwarz/black  
101012154 weiß/white



48,00 €  
48,00 €

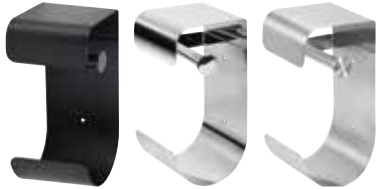

**Doppelter Toilettenpapierhalter, Edelstahl**

Double toilet paper holder, stainless steel  
125×260×125 mm  
104112200 schwarz/black  
104112201 poliert/polished  
104112205 gebürstet/brushed



87,00 €  
89,00 €  
79,00 €



**Doppelter Toilettenpapierhalter mit Deckel**

Double paper holder with cover  
270×140×107 mm  
104112092



103,00 €



**Doppelter Toilettenpapierhalter**

Double paper holder, stainless steel, matt  
320×30×90 mm  
146212245



80,00 €



**Doppelpapierrollenhalter**

Double toilet paper holder  
254×53×67 mm  
101012045



69,00 €



**Einbaut Toilettenpapierrollenhalter, poliert**

Integrated toilet paper holder, stainless steel, polished  
200×60×100 mm  
134103012



56,00 €



**Toilettenpapierhalter, Einbau, mit Abdeckung, Edelstahl, poliert**

Toilet paper holder, built-in, with cover, stainless steel, polished  
154×164×75 mm  
104112125



58,00 €



**Toilettenpapierhalter, doppelt, zum Einbau, mit Abdeckung, Edelstahl, poliert**

Toilet paper holder, built-in, with cover, stainless steel, polished  
294×164×75 mm  
104112435



90,00 €



**Ständer, mit Toilettenpapierhalter, mit WC-Bürste, mit Ablage, Edelstahl, poliert**

Stand, with toilet paper holder, with toilet brush, with shelf, stainless steel, polished  
135×625×200 mm  
172836012



150,00 €



**Toilettenpapierhalter, doppelt, zum Einbau, mit Abdeckung, Edelstahl, poliert**

Toilet paper holder, built-in, with cover, stainless steel, polished  
154×314×75 mm  
104112445



90,00 €



**WC-Bürste, wandhängend**

Wall mounted toilet brush holder  
110×400×115 mm  
101113335



41,00 €



**WC-Bürstenbox**

Toilet brush box  
148×448×129 mm  
101013175



271,00 €



**Urinal-Trennwand, Edelstahl, schwarz**

Urinal partition, stainless steel, brushed  
180×735×355 mm  
101542070



310,00 €



**Urinal-Trennwand, Edelstahl**

Urinal partitions, stainless steel, polished  
60×860×400 mm  
101042065



187,00 €



**Urinal-Trennwand, Edelstahl**

Urinal partitions, stainless steel, brushed  
30×800×390 mm  
101042075



199,00 €



**Kleiderhaken, Edelstahl/  
Messing, Chrom**

Single robe hook,  
stainless steel/brass, chrome

54×54×100 mm

146106312



28,00 €



**Kleiderhaken, Edelstahl/  
Messing, gebürstet**

Single robe hook,  
stainless steel/brass, brushed

55×55×60 mm

146106305



19,00 €



**Kleiderhaken, Edelstahl/  
Messing, gebürstet**

Single robe hook,  
stainless steel/brass, brushed

35×43×26 mm

146106175



18,00 €



**Kleiderhaken, Zinc/Messing,  
gebürstet**

Hanger, zinc/brass, brushed

25×52×35 mm

172206015



13,00 €



**Doppelkleiderhaken,  
Zinc/Messing, gebürstet**

Hanger, with 2 hooks  
zinc/brass, brushed

60×55×45 mm

172206035



21,00 €



**Hakenleiste, mit 4 Haken,  
Zinc/Messing, gebürstet**

Hanger, with 4 hooks  
zinc/brass, brushed

60×55×45 mm

172206055



40,00 €



**Doppelkleiderhaken  
Edelstahl/Messing, gebürstet**

Hanger, with 2 hooks  
stainless steel/brass, brushed

115×45×32 mm

132206035



28,00 €



**Hakenleiste mit 3 Haken,  
Edelstahl/Messing, gebürstet**

Hanger, with 3 hooks  
stainless steel/brass, brushed

185×45×32 mm

132206045



38,00 €



**Hakenleiste mit 4 Haken,  
Edelstahl/Messing, gebürstet**

Hanger, with 4 hooks  
stainless steel/brass, brushed

255×45×32 mm

132206055



47,00 €



**Hakenleiste mit 3 Haken**

Triple hook

220×30×40 mm

106105181



21,00 €



**Wandtürstopper, Edelstahl**

Door stop on wall, stainless steel

46×65×100 mm

poliert/polished

346218121

gebürstet/brushed

346218125



17,00 €



**Wandtürstopper, Edelstahl**

Door stop on wall, stainless steel

50×95×50 mm

poliert/polished

346218021

gebürstet/brushed

346218025



20,00 €

13,00 €



**Bodentürstopper, Edelstahl**

Door stop on floor, stainless steel

37×40×37 mm

346218211 poliert/polished

346218215 gebürstet/brushed



20,00 €

16,00 €



**Bodentürstopper, Edelstahl**

Door stop on floor, stainless steel

35×40×35 mm

346218011 poliert/polished

346218015 gebürstet/brushed



21,00 €

14,00 €



**Bodentürstopper, Edelstahl**

Door stop on floor, stainless steel

46×46×46 mm

346218111 poliert/polished

346218115 gebürstet/brushed



13,00 €

8,00 €



**Wandtürstopper**

Door stop on wall

18×18×80 mm

101218022 chrom/chrome

101218025 gebürstet/brushed

101218027 Gold/gold

101218020 schwarz/black



31,00 €

28,00 €

34,00 €

25,00 €



**Bodentürstopper**

Door stop on floor

33×30×33 mm

101218012 chrom/chrome

101218015 gebürstet/brushed

101218017 Gold/gold

101218010 schwarz/black



23,00 €

21,00 €

33,00 €

22,00 €



**Handtuchhalter, Edelmetall/Messing, Chrom**

Towel holder polished, stainless steel/brass, chromed

55×55×500 mm

146104442



46,00 €



**Handtuchhalter, Edelmetall/Messing, Chrom**

Towel holder polished, stainless steel/brass, chromed

1 170×54×63 mm

146104432



88,00 €



**Badrollwagen**

Trolley

450×820×300 mm

104832012

370,00 €



**Wäscheleine, poliert**

Clothesline, polished

ø 95×45 mm, l = 2600 mm

123126022



39,00 €



**Flaschenöffner, Edelmetall, poliert**

Bottle opener, stainless steel, polished

45×65×40 mm

101832011



30,00 €

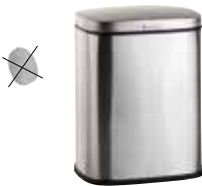

**Abfalleimer, Edelmetall, poliert**

Waste bin, stainless steel, polished

180×245×135 mm, 3 l

125115025

49,00 €



**Abfallbehälter, Edelmetall, matt**

Waste bin, stainless steel, brushed

240×235×145 mm, 4 l

146115015

63,00 €

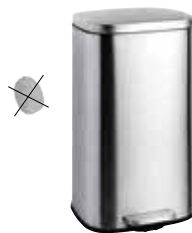

**Abfalleimer, Edelmetall, poliert**

Waste bin, stainless steel, polished

140×265×270 mm, 5 l

125115015

51,00 €



**Abfalleimer, Edelmetall, poliert**

Waste bin, stainless steel, polished

345×630×295 mm, 30 l

125115095

159,00 €



**Abfalleimer, Edelmetall, poliert**

Waste bin, stainless steel, polished

425×655×375 mm, 50 l

125115325

292,00 €



**Abfalleimer, Edelmetall, poliert**

Pedal bin, stainless steel, polished

200×300×200 mm, 6 l

125115071

52,00 €

**Abfalleimer, Edelmetall matt**

Table bin with cover, stainless steel brushed

120×155×120 mm, 1,5 l

137115205

41,00 €

**Wand-Abfalleimer, Edelstahl**

Wall mounted waste bin, stainless steel

170×235×240mm, 3l

125115051 poliert/polished

41,00 €

125115055 gebürstet/brushed

41,00 €

**Abfalleimer, wandhängend**

Square waste bin, wall mounted

205×300×100 mm, 6 l

101915051 poliert/polished

114,00 €

101915054 weiß/white

93,00 €

101915055 gebürstet/brushed

102,00 €

101915050 schwarz/black

86,00 €

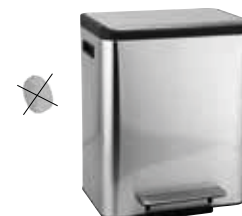
**Abfalleimer, wandhängend, Edelstahl, weiß**

Wall mounted waste bin, stainless steel, white

190×265×90 mm, 5 l

105115054

94,00 €

105115055

94,00 €

**Abfalleimer 15 L. + 15 L., „Soft-Close“, Edelstahl matt**

Recycling trash Can double 15 l+15l; stainless steel brushed; softclose

400×490×320mm, 15l + 15l

137115165

205,00 €

**Abfalleimer, Edelstahl**

Pedal bin, stainless steel

poliert/polished

104315022 170×255×170 mm, 3l

27,00 €

104315012 200×280×200 mm, 5l

34,00 €

104315032 250×390×250 mm, 12l

56,00 €

104315082 300×450×300 mm, 20l

114,00 €

104315092 300×650×300 mm, 30l

137,00 €

104315102 350×650×350 mm, 40l

190,00 €

gebürstet/brushed

104315025 170×255×170 mm, 3l

26,00 €

104315052 200×280×200 mm, 5l

44,00 €

104315035 250 × 390 × 250 mm, 12 l

56,00 €

104315085 300 × 450 × 300 mm, 20 l

114,00 €

**Abfalleimer, Edelstahl gebürstet**

Recycling waste bin, stainless steel brushed

590×435×375 mm, 3×14 l

104315262

148,00 €

**Abfalleimer, Edelstahl gebürstet**

Recycling waste bin, stainless steel brushed

590×435×375 mm, 2×20 l

104315272

137,00 €

**Abfalleimer, Edelstahl**

Waste bin, stainless steel

225×305×165 mm, 6 l

126115390 gold/gold

53,00 €

126115393 dunkelgold/dark gold

53,00 €

126115395 grau/gray

52,00 €

126115398 schwarz/black

53,00 €

**Abfalleimer, Edelstahl**

Waste sorting bin, stainless steel

250×315×250 mm, 15 l

126115380 schwarz/black

63,00 €

126115385 gebürstet/brushed

73,00 €

**Abfalleimer, Edelstahl**

Waste sorting bin, stainless steel

250×315×250 mm, 15 l

126115370 schwarz/black

63,00 €

126115375 gebürstet/brushed

73,00 €

**Abfalleimer, Edelstahl gebürstet**

Room bin, stainless steel, matt

245×310×245 mm, 13 l

150115161

95,00 €

**Abfalleimer, Edelstahl schwarz**

Room bin, stainless steel black

250×295×250 mm, 7,5l

150115151

59,00 €

**Abfalleimer ohne Deckel, Edelstahl**

Waste bin without cover, stainless steel

240×340×240 mm, 9l

137115225

115,00 €

**Abfalleimer**

Waste bin

298×448×170 mm, 21 l

101015305

132,00 €



**Abfalleimer , Edelstahl**

Waste bin without cover, stainless steel  
200×270×200 mm, 9 l

poliert/polished 115115031 48,00 €  
gebürstet/brushed 115115035 48,00 €

**Rechteckiger Abfalleimer, stehend oder wandhängend, Edelstahl**

Square waste bin, free standing/wall mounted, stainless steel  
370×460×165 mm, 25 l

poliert/polished 125115041 222,00 €  
gebürstet/brushed 125115045 207,00 €

**Rechteckiger Abfalleimer, wandhängend**

Waste bin square, wall mounted

poliert/polished

101915111 250×500×250 mm, 25 l 235,00 €  
101915121 300×600×250 mm, 45 l 359,00 €  
101915131 300×600×400 mm, 75 l 570,00 €

gebürstet/brushed

101915115 250×500×250 mm, 25 l 235,00 €  
101915125 300×600×250 mm, 45 l 359,00 €  
101915135 300×600×400 mm, 75 l 570,00 €

schwarz/black

101915110 250×500×250 mm, 25 l 214,00 €

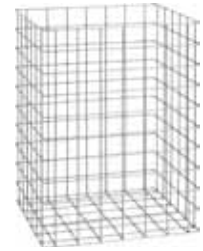

**Abfalleimer 90 L, Edelstahl matt**

Open trash can 90l, stainless steel brushed  
450×755×430 mm, 90 l

137115215 401,00 €

**Drahtkorb**

Wired waste bin

353×503×305 mm, 52 l

101015065 175,00 €

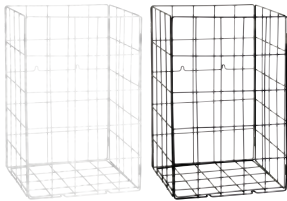

**Drahtkorb, Stahl**

Wire basket, steel

350×550×265 mm, 50 l

153115064 weiß/white 85,00 €  
153115060 schwarz/black 85,00 €

**Drahtkorb mit fester Wand vorne zum Aufhängen**

Hanging wired waste bin with fixed front

455×603×255 mm, 67 l 263,00 €

**Behälter mit Drahtkorb**

Wired waste bin in receptacle

300×600×330 mm, 45 l 584,00 €

**Hygieneabfallbehälter mit Beutelspender**

A waste bin with a dispenser for sanitary bags and a plastic container

230×300×115 mm, 6,5 l 125,00 €



**Abfallbehälter mit Hygienebeutelspender**

Waste bin with dispenser for sanitary bags

300×450×130 mm, 4 l 403,00 €

**Abfallbehälter mit Hygienebeutelspender zum Wandeinbau**

Recessed waste bin with dispenser for sanitary bags

226×570×130 mm, 4 l 223,00 €

**Drahtkorb, Edelstahl, gebürstet**

Wired waste bin, stainless steel, brushed

312×497×217 mm, 30 l 74,00 €

**Drahtkorb, Edelstahl, weiß**

Wired waste bin, stainless steel, white

312×497×217 mm, 30 l 58,00 €

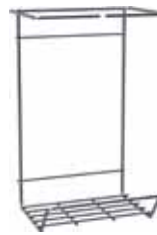

**Durchwurfring zum Einbau**

Countertop-mounted circular waste chute

170×42×170 mm, ø 135 mm 69,00 €

**Quadratischer Abfallschacht zum Einbau**

Countertop-mounted lid trash bin cover

300×150×30 mm 122,00 €

**Aschenbecher, poliert**

Ash tray, polished

100×120×35 mm 23,00 €

**Aschenbecher stehend für Außenbereich**

Ashtray outdoor

298× 800×298 mm 201,00 €



### Automatischer Händetrockner, Edelstahl, gebürstet

Automatic hand dryer, stainless steel, brushed

245×370×102 mm, 1000 W

924224175



560,00 €



### Händetrockner, Edelstahl

Automatic hand dryer, stainless steel

290×325×105 mm, 1000 W

924224110 schwarz/black

924224111 poliert/polished

924224115 gebürstet/brushed

444,00 €

444,00 €

444,00 €



### Händetrockner, Edelstahl

Automatic hand dryer, stainless steel

173×255×150 mm, 1350 W

924224130 schwarz/black

924224131 poliert/polished

924224135 gebürstet/brushed



341,00 €

341,00 €

341,00 €



### Händetrockner, Edelstahl

Automatic hand dryer, stainless steel

295×320×162 mm, 1800 W

924224120 schwarz/black

924224121 poliert/polished

924224125 gebürstet/brushed

469,00 €

469,00 €

469,00 €



### Händetrockner, Edelstahl

Automatic hand dryer, stainless steel

260×230×205 mm, 2300 W

924224140 schwarz/black

924224141 poliert/polished

924224145 gebürstet/brushed

474,00 €

474,00 €

474,00 €



### Händetrockner, Edelstahl

Automatic hand dryer, stainless steel

170×255×100 mm, 700 W

924224150 schwarz/black

924224155 gebürstet/brushed



284,00 €

284,00 €



### Händetrockner, Edelstahl

Automatic hand dryer, stainless steel

270×240×200 mm, 2500 W

945224061 poliert/polished

106224015 gebürstet/brushed

616,00 €

595,00 €



### Kontaktloser Händetrockner, Kunststoff weiß

Automatic hand dryer, plastic, white

220×280×150 mm, 1650 W

924224184



160,00 €



### Händetrockner mit HEPA-Filter, Kunststoff

Automatic hand dryer, HEPA filter, plastic

297×665×183 mm, 1650 W

924224163 silber/silver

924224164 weiß/white



1 360,00 €

1 224,00 €



### Kontaktloser Händetrockner, weiß

Hand dryer, plastic white

240×240×230 mm, 1800 W

945224016



182,00 €

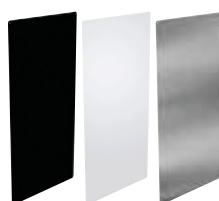

### Spritzschutz für Händetrockner

Splash guard for hand dryer

400×800×1 mm

101044050 schwarz/black

101044055 poliert/polished

101043065 gebürstet/brushed

119,00 €

105,00 €

105,00 €

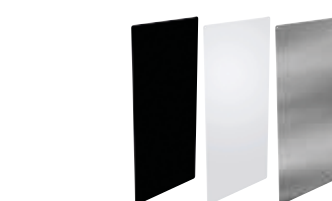

### Spritzschutz für Händetrockner zum Kleben

Splash guard for hand dryer for sticking

400×800×1 mm

101043050 schwarz/black

101043055 poliert/polished

101043065 gebürstet/brushed



119,00 €

105,00 €

105,00 €



**Fön ohne Wandhalter, Ionisation, schwarz**

Hair dryer, without holder, ionic function, black  
60×229×77 mm, 1 400 W  
geradeschnur/straight cable  
946233106

140,00 €



**Hotel-Fön**

Hotel hair dryer  
160×223×100 mm, 1 350 W  
924533015

600,00 €



**Hotel-Fön**

Hotel Hairdryer  
180×370×120mm, 900 W  
945133016

162,00 €



**Fön wandmontiert mit Halterung, grau**

Hair dryer wall-mounted with holder, grey  
160×223×100 mm, 2 000 W  
946233066

88,00 €



**Fön ohne Wandhalter, Ionisation**

Hairdryer without holder, ionic function  
90×260×190 mm, 1 800 W  
945533166 grau/gray  
945533168 schwarz/black

97,00 €  
88,00 €



**Fön mit Wandhalter**

Hairdryer with holder and socket  
110×240×310 mm, 1 600 W  
945533154 weiß/white  
945533158 schwarz/black

111,00 €  
111,00 €



**Fön mit Wandhalter**

Hairdryer with holder  
110×245×140 mm, 1 400 W  
945533074

86,00 €



**Fön mit Wandhalter**

Hairdryer with holder  
110×240×310mm, 1 400 W  
945233066

95,00 €



**Fön mit Wandhalter**

Hairdryer with holder  
75×270×190mm, 1 400 W  
999433084 weiß/white - Gerade/straight cable  
999433084-2 weiß/white - Ringschnur/twisted cable  
999433088 schwarz/black - Ringschnur/twisted cabl

107,00 €  
107,00 €  
107,00 €



**Fön ohne Wandhalter**

Hairdryer without holder  
75×270×190mm, 1 400 W  
945433084  
945433088

68,00 €  
68,00 €



**Fönhalter  
Hairdryer holder**

80×55×100mm  
101117012

37,00 €



**Föntasche**

Hairdryer bag  
250×320×10 mm  
199100200

11,00 €



**Spiral Fönhalter**

Hairdryer holder, spiral  
105×118×123 mm  
132117022 quadratisch/square  
100×130×125 mm  
104117022 rund/round

46,00 €  
41,00 €

**Duschklapsitz, KS weiß – Edelstahl**

Reversible shower seat, stainless steel

462×120×450 mm

347125010 schwarz/black

347125011 gebürstet/brushed



412,00 €

409,00 €

**Duschklapsitz mit Stützbein**

Reversible shower seat with supporting leg

350×433×365 mm

205125035



442,00 €

**Duschklapsitz, transparent, poliert**

Folding shower seat, transparent, polished

380×460×555 mm

326325056



197,00 €

**Duschklapsitz mit Stützbein**

Reversible shower seat with supporting leg

440×460×450 mm

301102181 poliert/polished

301102182 gebürstet/brushed



321,00 €

338,00 €

**Abnehmbarer Griff mit Abdeckung, Edelstahl, poliert**

Removable grab bar with cover, stainless steel, polished

450×100×70 mm

301507862



297,00 €

**Abnehmbarer Griff mit Abdeckung, Edelstahl, poliert**

Removable grab bar with cover, stainless steel, polished

600×100×70 mm

301507852



309,00 €

**Wannengriff, poliert**

Bath grab bar, polished

340×60×80 mm

106107011



34,00 €

**Wannengriff abgewinkelt 135°, poliert**

Bath grab bar angled 135°, polished

390×230×80 mm

106107021



52,00 €

**Wannengriff abgewinkelt 135° mit Duschkorb, poliert**

Bath grab bar angled 135° with Shower shelf, polished

455×250×120 mm

106107031



64,00 €

**Rückenlehne mit Griff, abnehmbar, Edelstahl, poliert**

Backrest with handle, removable, stainless steel, polished

400×180×230 mm

301507882



447,00 €

**Konsole für Waschbeckenplatte**

Washbasin bracket

rechts/right



links/left

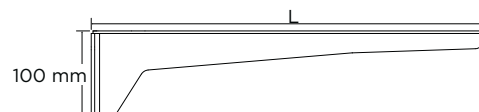

Konsole/Bracket		Packung mit 1 Paar Package 1 pair	Belastung/Weight	
L = 300 mm	201541014		30 kg	83,00 €
L = 400 mm	201541024		30 kg	91,00 €
L = 400 mm	201541034		50 kg	96,00 €
L = 450 mm	201541044		50 kg	103,00 €

**Konsole für Waschbeckenplatte**

Wash Basin Bracket rectangular

rechts/right



links/left

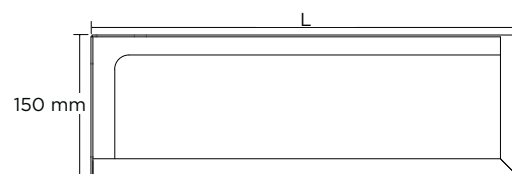

	L			
Edelstahl poliert/Stainless polished	490 mm	201541061	rechts/right	142,00 €
Edelstahl poliert/Stainless polished	490 mm	201541051	links/left	142,00 €
Stahl weiß/Fe white	490 mm	201541064	rechts/right	101,00 €
Stahl weiß/Fe white	490 mm	201541054	links/left	101,00 €
Stahl black/Fe schwarz	490 mm	201541060	rechts/right	98,00 €
Stahl black/Fe schwarz	490 mm	201541050	links/left	98,00 €



**Set Badezimmerzubehör (5 St.), Kunststoff/weiß**  
Set of bathroom accessories, 5 pcs, plastic/white  
290000209

92,00 €

**Set Badezimmerzubehör (5 St.), Kunststoff/schwarz**  
Set of bathroom accessories, 5 pcs, plastic/black  
290000208

92,00 €



**WC**  
WC

**A**  
75×75×2 mm  
111054006 poliert/polished **11,00 €**



**WC Damen**  
Women

**A**  
75×75×2 mm  
111054007 poliert/polished **11,00 €**



**WC Herren**  
Gentlemen' toilet

**A**  
75×75×2 mm  
111054002 poliert/polished **11,00 €**



**Damen und Herren**  
Women and Men

**A**  
75×75×2 mm  
111054072 poliert/polished **11,00 €**



**Behinderte**  
Disabled toilets

**A**  
75×75×2 mm  
111054001 poliert/polished **11,00 €**



**Duschen**  
Showers

**A**  
75×75×2 mm  
111054004 poliert/polished **11,00 €**



**Putzraum**  
Cleaning room

**A**  
75×75×2 mm  
111054005 poliert/polished **11,00 €**



**Wickelraum**  
Baby nursery room

**A**  
75×75×2 mm  
111054003 poliert/polished **11,00 €**



**Rauchen erlaubt**  
Smoking

**A**  
75×75×2 mm  
111054021 poliert/polished **11,00 €**



**Rauchen verboten**  
No smoking

**A**  
75×75×2 mm  
111054022 poliert/polished **11,00 €**



**Wandbefestigung für Symbole**  
Wall pad for icon

**A**  
65×65×2 mm  
111054999 **3,00 €**

## Komplette Menüsymbole

Complete menu icons



Name name	Bestellnummer Order- ing number Eisen, leuchten circle, polished	Bestellnummer Order- ing number Eis, matt circle, mat	Bestellnummer Order- ing number quadratisch, glänzen square, polished	Bestellnummer Order- ing number quadratisch, matt square, mat
--------------	---	--	--	--

	Behinderte/disabled	111054001	111055001	111056001	111057001
	Herr/en/man	111054002	111055002	111056002	111057002
	Damen/woman	111054007	111055007	111056007	111057007
	Damen und Herren man and woman	111054072	111055072	111056072	111057072
	Wickelraum baby nursery room	111054003	111055003	111056003	111057003
	Duschen/shower	111054004	111055004	111056004	111057004
	Putzraum/cleaning room	111054005	111055005	111056005	111057005
	wc	111054006	111055006	111056006	111057006
	Schwimmbad swimming pool	111054008	111055008	111056008	111057008
	Kinder/children	111054009	111055009	111056009	111057009
	Kinderecke/children's corner	111054010	111055010	111056010	111057010
	Kinderwagen/carriage house	111054011	111055011	111056011	111057011
	Fahrradschuppen/bike shed	111054012	111055012	111056012	111057012
	Mülleimer/basket	111054013	111055013	111056013	111057013
	Kapelle/chapel	111054014	111055014	111056014	111057014
	Kasse/cash register	111054015	111055015	111056015	111057015
	Fitness/fitness	111054016	111055016	111056016	111057016
	Garderobe/cloaroom	111054017	111055017	111056017	111057017
	Whirlpool/whirlpool	111054018	111055018	111056018	111057018
	Wellness/wellness	111054019	111055019	111056019	111057019
	Wi-fi/wi-fi	111054020	111055020	111056020	111057020
	Rauchen erlaubt/smoking	111054021	111055021	111056021	111057021
	Rauchen verboten no smoking	111054022	111055022	111056022	111057022
	Fotografieren verboten No photography allowed	111054023	111055023	111056023	111057023
	Essen verboten food prohibited	111054024	111055024	111056024	111057024
	Verbot 1/ban 1	111054025	111055025	111056025	111057025
	Verbot 2/ban 2	111054026	111055026	111056026	111057026
	Tiere an der Leine animals on a leash	111054027	111055027	111056027	111057027
	Haustiere verboten pets prohibited	111054028	111055028	111056028	111057028
	Ziffer/numeral	111054029	111055029	111056029	111057029
	Rolltreppe/escalator	111054030	111055030	111056030	111057030
	Rolltreppe runter escalator down	111054031	111055031	111056031	111057031
	Rolltreppe hoch/escalator up	111054032	111055032	111056032	111057032
	Etage/floor	111054033	111055033	111056033	111057033
	Information/information	111054034	111055034	111056034	111057034
	Obergeschoss above ground floor	111054035	111055035	111056035	111057035



Name name	Bestellnummer Order- ing number Eisen, leuchten circle, polished	Bestellnummer Order- ing number Eis, matt circle, mat	Bestellnummer Order- ing number quadratisch, glänzen square, polished	Bestellnummer Order- ing number quadratisch, matt square, mat
--------------	---	--	--	--

	Parken/parking	111054036	111055036	111056036	111057036
	Etage/floor	111054037	111055037	111056037	111057037
	Treppe runter/down the stairs	111054038	111055038	111056038	111057038
	Treppe hinauf/upstairs	111054039	111055039	111056039	111057039
	Kellergeschoß underground floor	111054040	111055040	111056040	111057040
	Zimmer/room	111054041	111055041	111056041	111057041
	Bindestrich "bis"/dash "up"	111054042	111055042	111056042	111057042
	pull	111054043	111055043	111056043	111057043
	pull-sem	111054044	111055044	111056044	111057044
	sem	111054048	111055048	111056048	111057048
	sem-pull	111054049	111055049	111056049	111057049
	push	111054045	111055045	111056045	111057045
	push-tam	111054046	111055046	111056046	111057046
	tam	111054054	111055054	111056054	111057054
	tam/push	111054055	111055055	111056055	111057055
	Rezeption/reception	111054047	111055047	111056047	111057047
	Pfeil/arrow	111054050	111055050	111056050	111057050
	Zwei-Wege-pfeil bidirectional arrow	111054051	111055051	111056051	111057051
	diagonal Pfeil nach links diagonal left arrow	111054052	111055052	111056052	111057052
	diagonal Pfeil nach rechts diagonal right arrow	111054053	111055053	111056053	111057053
	Notausgang/emergency exit	111054056	111055056	111056056	111057056
	Eingang/entrance	111054057	111055057	111056057	111057057
	Ausweg/exit	111054058	111055058	111056058	111057058
	Aufzug/lift	111054059	111055059	111056059	111057059
	Bar/bar	111054060	111055060	111056060	111057060
	Cafe/cafe	111054061	111055061	111056061	111057061
	Küche/kitchen	111054062	111055062	111056062	111057062
	Restaurant/restaurant	111054063	111055063	111056063	111057063
	Überwachungskamera safety camera	111054064	111055064	111056064	111057064
	Desinfektion/disinfection	111054065	111055065	111056065	111057065
	Feuerlöscher/fire extinguisher	111054066	111055066	111056066	111057066
	Erste-Hilfe-Kasten first aid kit	111054067	111055067	111056067	111057067
	Feuerwehrschauch fire hose	111054068	111055068	111056068	111057068
	Abstand/spacing	111054069	111055069	111056069	111057069
	Mund bedecken covering mouth	111054070	111055070	111056070	111057070
	Sanitäter/paramedic	111054071	111055071	111056071	111057071



**WC Herren**

Gentlemen's toilet

120×120×2 mm

111022032 poliert/polished

111022035 gebürstet/brushed

30,00 €



**WC Damen**

Ladies' toilets

120×120×2 mm

111022042 poliert/polished

111022045 gebürstet/brushed

30,00 €



**Barrierefreies WC**

Disabled toilets

120×120×2 mm

111022022 poliert/polished

111022025 gebürstet/brushed

30,00 €



**WC**

120×120×2 mm

111022082 poliert/polished

111022085 gebürstet/brushed

30,00 €



**Duschen**

Showers

120×120×2 mm

111022072 poliert/polished

111022075 gebürstet/brushed

36,00 €



**Abstellraum**

Cleaning room

120×120×2 mm

111022092 poliert/polished

111022095 gebürstet/brushed

26,00 €



**Rauchen gestattet**

Smoking

120×120×2 mm

111022012 poliert/polished

111022015 gebürstet/brushed

31,00 €



**Rauchen verboten**

No smoking

120×120×2 mm

111022052 poliert/polished

111022055 gebürstet/brushed

31,00 €



**Wickelraum**

Baby nursery room

120×120×2 mm

111022062 poliert/polished

111022065 gebürstet/brushed

26,00 €



**WC Damen**

Ladies' toilets

40×85×2 mm

108022062 poliert/polished

108022065 gebürstet/brushed

13,00 €



**WC Herren**

Gentlemen's toilet

40×85×2 mm

108022052 poliert/polished

108022055 gebürstet/brushed

13,00 €



**Wandwickeltisch, horizontal, Kunststoff**

Wall mounted baby changing station, horizontal, plastic

855×585×107/495 mm

138235016



474,00 €

**Wandwickeltisch, Edelstahl-Kunststoff, gebürstet**

Wall mounted baby changing station, SS-plastic, brushed

900×520×105/510 mm

138235035



1 677,00 €



**Wandwickeltisch, horizontal, Kunststoff**

Wall mounted baby changing station, horizontal, plastic

480×870×126/885 mm

138235026



614,00 €

**Spiegel Edelstahl**

Mirror - stainless supermirror

600×800 mm

101301652



237,00 €

# DUSCHZUBEHÖR

SHOWER PROGRAM



**Duschkappsitz, Kunststoff, schwarz**  
Folding shower seat, plastic black  
345×395×330 mm  
105125030 500,00 €



**Duschkappsitz, Kunststoff, weiß**  
Folding shower seat, plastic white  
345×395×330 mm  
105125034 500,00 €



**Duschkappsitz, schwarz - Edelstahl**  
Shower seat  
350×70×335 mm  
203125064 136,00 €



**Duschkappsitz, schwarz - Edelstahl**  
Shower seat  
350×70×340 mm  
203125074 schwarz/black 204,00 €  
203025074 creme/cream 204,00 €



**Duschvorhang, weiß, PEVA Kunststoff**  
Shower curtain, white, PEVA plastic

153653016 180 cm ×180 cm  
für Duschstange/for shower curtain: 101120071, 101114361

153653026 200 cm×180 cm  
für Duschstange/for shower curtain: 101120081, 101120012

153653036 240 cm×180 cm  
für Duschstange/for shower curtain: 101120091, 101120022, 101120111, 101120042

153653046 300 cm×180 cm  
für Duschstange/for shower curtain: 101120101, 101120032

153653066 360 cm×180 cm  
für Duschstange/for shower curtain: 101120121, 101120052

16,00 €

18,00 €

23,00 €

30,00 €

36,00 €



**Duschkappsitz mit Stützbein**  
Reversible shower seat with supporting leg  
350×433×365 mm  
205125035 442,00 €



**Duschstange mit Halter, poliert**  
Shower rail with holder, polished  
90×650×70 mm  
104114112 116,00 €



**Duschabzieher**  
Shower squeegee  
260×250×38 mm  
172237010 schwarz/black 46,00 €  
172237012 poliert/polished 40,00 €



**Haken für Duschvorhang, 12 St.**  
Hooks for shower curtains, 12 pc.  
42×73×8 mm  
nerez/stainless steel  
153653502 13,00 €  
54×80×10 mm  
Kunststoff/plastic  
153653506 5,00 €



**Duschvorhangstange, Edelstahl poliert\***  
Shower curtain holder, stainless steel, polished\*

101114361 ø 25mm, 900 mm 84,00 €  
101120012 ø 25mm, 1 000 mm 87,00 €  
101120022 ø 25mm, 1 500 mm 104,00 €  
101120032 ø 25mm, 2 000 mm 122,00 €



**Duschvorhangstange modular, Edelstahl, poliert\***  
Shower curtain holder, corner model, assembled, stainless steel, polished\*  
101120111 ø 25 mm, 900×500×900 mm 201,00 €  
101120121 ø 25 mm, 1 400×500×1 400 mm 238,00 €



**Duschvorhangstange, Eckmodell, Edelstahl poliert\***  
Shower curtain holder, corner model, stainless steel, polished\*

ø 25 mm, 900×500×900 mm 174,00 €  
101120042 ø 25 mm, 1 400×500×1 400 mm 229,00 €



**Duschvorhangstange modular, Edelstahl, poliert\***  
Shower curtain holder, assembled, stainless steel, polished\*

101120071 ø 25 mm, 900 mm 73,00 €  
101120081 ø 25 mm, 1 000 mm 79,00 €  
101120091 ø 25 mm, 1 500 mm 95,00 €  
101120101 ø 25 mm, 2 000 mm 111,00 €



**Duschvorhangstange modular, Edelstahl, schwarz\***  
Shower curtain holder, corner model, assembled, stainless steel, black\*  
ø 25 mm, 900×500×900 mm 201,00 €



**Stellen Sie aus unseren Komponenten Ihren individuellen Duschvorhanghalter zusammen**

Assemble your custom shower curtain holder from our components

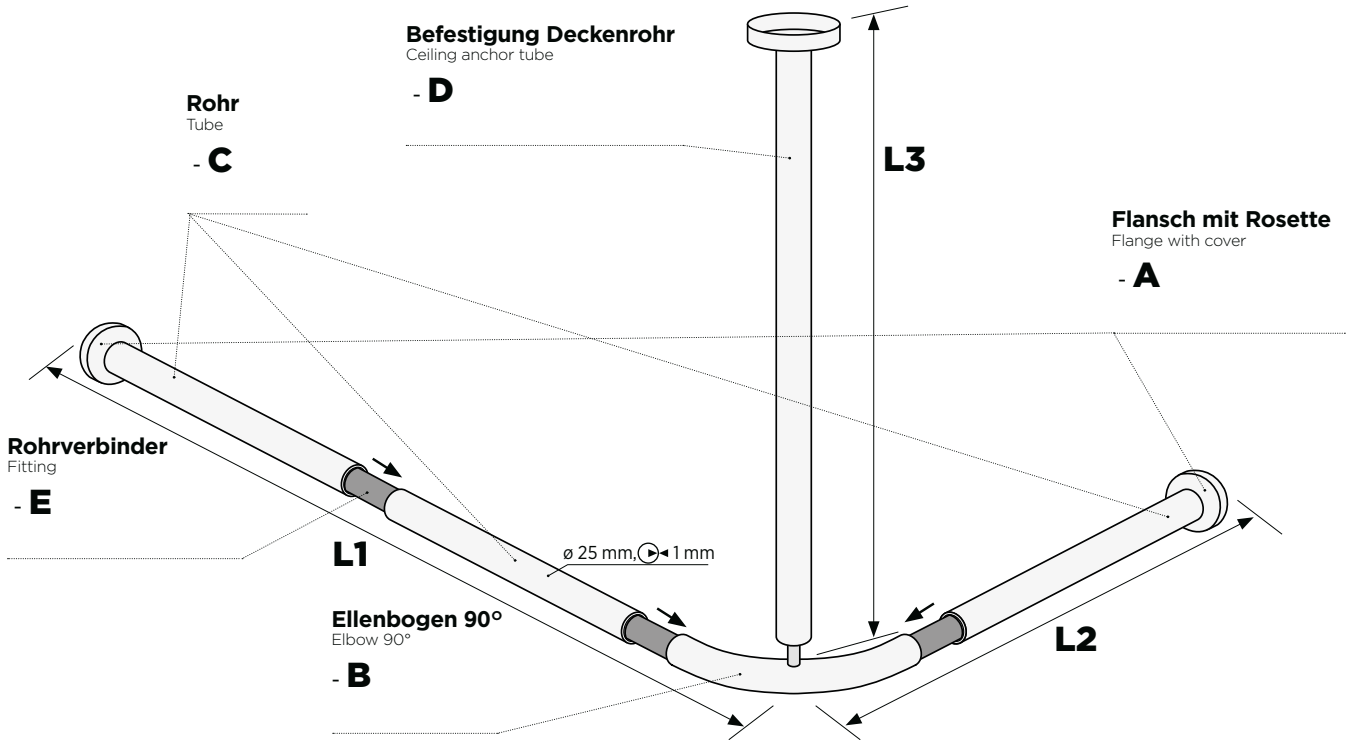

**Vorgehensweise zum Messen von individuellen Duschvorhangstangensets:**  
**Procedure for measuring individual lengths of shower curtain rods:**

L1:	$A + B$	$+ C + C$
	$= 100 \text{ mm}$	
L2:	$A + B$	$+ C$
	$= 100 \text{ mm}$	
L3:	$D$	



**Flansch mit Rosette + 3× Dübel, 3× Schrauben**  
 Flange with cover + 3× Wall plug, 3× screw

**- A**  
 101120132 24,00 €



**Rohrverbinder**  
 Fitting

**- E**  
 101120152 15,00 €



**Eckverbinder 90° + 2 x Rohrverbinder**  
 Elbow 90° + 2× fitting

**- B**  
 101120222 34,00 €

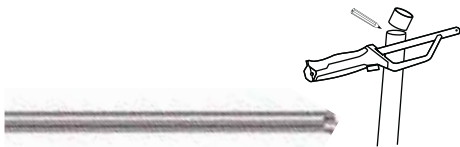

<b>Rohr</b> Tube - <b>C</b>		
600 mm	101120162	18,00 €
700 mm	101120172	21,00 €
800 mm	101120182	23,00 €
900 mm	101120192	25,00 €
1000 mm	101120202	26,00 €
1170 mm	101120271	39,00 €



<b>Befestigung Deckenrohr</b> Ceiling anchor tube - <b>D</b>		
300 mm	101120241	72,00 €
500 mm	101120142	76,00 €
800 mm	101120251	83,00 €
1200 mm	101120261	91,00 €

# HELP

## Wannengriff, Edelstahl, poliert

Grab bar, stainless steel, polished

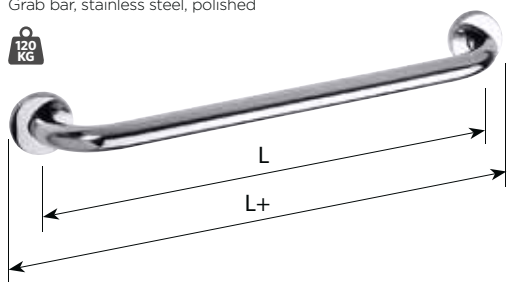

## Wannengriff, Edelstahl, gebürstet

Grab bar, stainless steel, matt



## Wannengriff, Pulverbeschichtet weiß

Grab bar, steel powder, coated white



## Wannengriff, Pulverbeschichtet weiß mit Abdeckung

Grab bar, steel powder, coated white



## Wannengriff, Pulverbeschichtet weiß mit Abdeckung

Grab bar, steel powder, coated white

Längen der Wannengriffe [L] Product length [L]	Ausführung Finish	Preis € Price €	Bestellnummer Ordering number
200 mm	poliert, mit Rosette/polished, with cover	54,00	301100201
	gebürstet, mit Rosette/matt, with cover	58,00	301100202
	weiß/white	37,00	301100204
300 mm	weiß mit Rosette/white with cover	52,00	301100203
	poliert/polished	63,00	301100301
	gebürstet, mit Rosette/matt, with cover	77,00	301100302
	weiß/white	37,00	301100304
400 mm	weiß mit Rosette/white with cover	59,00	301100303
	schwarz mit Rosette/black with cover	61,00	301100300
	poliert/polished	69,00	301100401
	gebürstet, mit Rosette/matt, with cover	78,00	301100402
	weiß/white	40,00	301100404
500 mm	weiß mit Rosette/white with cover	67,00	301100403
	schwarz mit Rosette/black with cover	67,00	301100400
	poliert/polished	86,00	301100501
	gebürstet, mit Rosette/matt, with cover	93,00	301100502
600 mm	weiß/white	44,00	301100504
	weiß mit Rosette/white with cover	67,00	301100503
	schwarz mit Rosette/black with cover	67,00	301100500
	poliert/polished	92,00	301100601
700 mm	gebürstet, mit Rosette/matt, with cover	90,00	301100602
	weiß/white	52,00	301100604
	weiß mit Rosette/white with cover	66,00	301100603
	schwarz mit Rosette/black with cover	70,00	301100600
800 mm	poliert/polished	92,00	301100701
	gebürstet, mit Rosette/matt, with cover	100,00	301100702
	weiß/white	55,00	301100704
900 mm	weiß mit Rosette/white with cover	75,00	301100703
	poliert/polished	100,00	301100801
	gebürstet, mit Rosette/matt, with cover	101,00	301100802
	weiß/white	66,00	301100804
1000 mm	weiß mit Rosette/white with cover	84,00	301100803
	poliert/polished	111,00	301100901
	gebürstet, mit Rosette/matt, with cover	120,00	301100902
	weiß/white	70,00	301100904
1100 mm	weiß mit Rosette/white with cover	77,00	301100903
	poliert/polished	120,00	301101001
	gebürstet, mit Rosette/matt, with cover	130,00	301101002
1200 mm	weiß/white	75,00	301101004
	weiß mit Rosette/white with cover	86,00	301101003
	poliert/polished	125,00	301101101
1500 mm	gebürstet, mit Rosette/matt, with cover	134,00	301101102
	weiß/white	79,00	301101104
	weiß mit Rosette/white with cover	105,00	301101103
1500 mm	poliert/polished	138,00	301101201
	gebürstet, mit Rosette/matt, with cover	141,00	301101202
	weiß/white	87,00	301101204
	weiß mit Rosette/white with cover	110,00	301101203
1500 mm	poliert/polished	167,00	301101501
	gebürstet, mit Rosette/matt, with cover	181,00	301101502
	weiß/white	104,00	301101504
	weiß mit Rosette/white with cover	124,00	301101503

### Stützgriff U-Form

Grab bar, U-shape

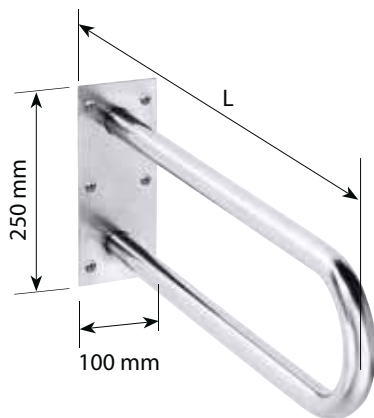

### Toilettenpapierhalter für Handläufe

Toilet paper holder for grab bar

47×96×150 mm

104112192

33,00 €

Längen der Wannengriffe [L] Product length [L]	Ausführung Finish	Preis € Price €	Bestellnummer Ordering number
<b>600 mm</b>	poliert, ohne Abdeckung/polished, without cover	125,00	301102051
	poliert mit Abdeckung/polished with cover	161,00	301707271
	gebürstet, ohne Abdeckung/matt, without cover	135,00	301102052
	gebürstet mit Abdeckung/matt with cover	161,00	301707272
	weiß, ohne Abdeckung/white, without cover	79,00	301102054
	weiß mit Abdeckung/white with cover	113,00	301707273
	schwarz mit Abdeckung/black with cover	113,00	301707270
<b>750 mm</b>	poliert, ohne Abdeckung/polished, without cover	134,00	301102301
	poliert mit Abdeckung/polished with cover	172,00	301707301
	gebürstet, ohne Abdeckung/matt, without cover	153,00	301102302
	gebürstet mit Abdeckung/matt with cover	172,00	301707302
	weiß, ohne Abdeckung/white, without cover	82,00	301102304
	weiß mit Abdeckung/white with cover	121,00	301707303
	<b>813 mm</b>	poliert, ohne Abdeckung/polished, without cover	178,00
poliert mit Abdeckung/polished with cover		182,00	301707461
gebürstet, ohne Abdeckung/matt, without cover		178,00	301102062
gebürstet mit Abdeckung/matt with cover		182,00	301707462
weiß, ohne Abdeckung/white, without cover		91,00	301102064
weiß mit Abdeckung/white with cover		120,00	301707463
schwarz mit Abdeckung/black with cover		128,00	301707460
<b>850 mm</b>	poliert, ohne Abdeckung/polished, without cover	186,00	301102041
	poliert mit Abdeckung/polished with cover	191,00	301707321
	gebürstet, ohne Abdeckung/matt, without cover	162,00	301102042
	gebürstet mit Abdeckung/matt with cover	191,00	301707322
	weiß, ohne Abdeckung/white, without cover	96,00	301102044
	weiß mit Abdeckung/white with cover	129,00	301707323
	<b>900 mm</b>	poliert, ohne Abdeckung/polished, without cover	163,00
poliert mit Abdeckung/polished with cover		201,00	301707331
gebürstet, ohne Abdeckung/matt, without cover		165,00	301102992
gebürstet mit Abdeckung/matt with cover		201,00	301707332
weiß, ohne Abdeckung/white, without cover		96,00	301102994
weiß mit Abdeckung/white with cover		134,00	301707333

### Rückenstütze

Grab bar, with backrest

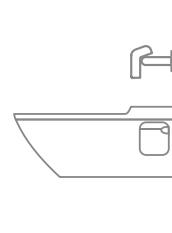
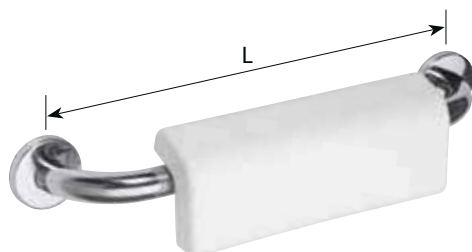

Längen der Wannengriffe [L] Product length [L]	Ausführung Finish	Preis € Price €	Bestellnummer Ordering number
<b>500 mm</b>	poliert mit Rosette/polished with cover	237,00	301100501-o
	gebürstet mit Rosette/matt with cover	254,00	301100502-o
	weiß, ohne Rosette/white, without cover	170,00	301100504-o
	weiß mit Rosette/white with cover	184,00	301100503-o

**Stützgriff U-Form mit Toilettenpapierhalter**

Grab bar, U-shape, with toilet paper holder

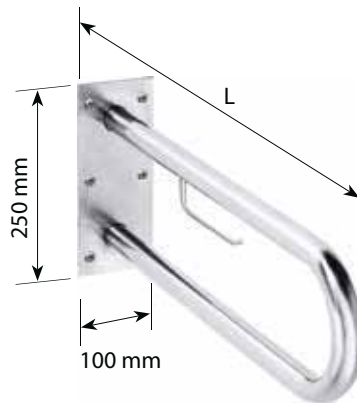

Längen der Wannengriffe [L] Product length [L]	Ausführung Finish	Preis € Price €	Bestellnummer Ordering number
<b>600 mm</b>	poliert, ohne Abdeckung/polished, without cover	<b>142,00</b>	<b>301907271</b>
	poliert, mit Abdeckung/polished, with cover	<b>183,00</b>	<b>301807271</b>
	gebürstet, ohne Abdeckung/matt, without cover	<b>152,00</b>	<b>301907272</b>
	gebürstet, mit Abdeckung/matt, with cover	<b>183,00</b>	<b>301807272</b>
	weiß, ohne Abdeckung/white, without cover	<b>94,00</b>	<b>301907274</b>
	weiß, mit Abdeckung/white, with cover	<b>132,00</b>	<b>301807273</b>
<b>750 mm</b>	poliert, ohne Abdeckung/polished, without cover	<b>162,00</b>	<b>301907301</b>
	poliert, mit Abdeckung/polished, with cover	<b>195,00</b>	<b>301807301</b>
	gebürstet, ohne Abdeckung/matt, without cover	<b>171,00</b>	<b>301907302</b>
	gebürstet, mit Abdeckung/matt, with cover	<b>195,00</b>	<b>301807302</b>
	weiß, ohne Abdeckung/white, without cover	<b>104,00</b>	<b>301907304</b>
	weiß, mit Abdeckung/white, with cover	<b>139,00</b>	<b>301807303</b>
<b>813 mm</b>	poliert, ohne Abdeckung/polished, without cover	<b>162,00</b>	<b>301907461</b>
	poliert, mit Abdeckung/polished, with cover	<b>215,00</b>	<b>301807461</b>
	gebürstet, ohne Abdeckung/matt, without cover	<b>176,00</b>	<b>301907462</b>
	gebürstet, mit Abdeckung/matt, with cover	<b>224,00</b>	<b>301807462</b>
	weiß, ohne Abdeckung/white, without cover	<b>105,00</b>	<b>301907464</b>
	weiß, mit Abdeckung/white, with cover	<b>162,00</b>	<b>301807463</b>
<b>850 mm</b>	poliert, ohne Abdeckung/polished, without cover	<b>177,00</b>	<b>301907321</b>
	poliert, mit Abdeckung/polished, with cover	<b>214,00</b>	<b>301807321</b>
	gebürstet, ohne Abdeckung/matt, without cover	<b>189,00</b>	<b>301907322</b>
	gebürstet, mit Abdeckung/matt, with cover	<b>189,00</b>	<b>301907322</b>
	weiß, ohne Abdeckung/white, without cover	<b>124,00</b>	<b>301907324</b>
	weiß, mit Abdeckung/white, with cover	<b>148,00</b>	<b>301807323</b>
<b>900 mm</b>	poliert, ohne Abdeckung/polished, without cover	<b>177,00</b>	<b>301907331</b>
	poliert, mit Abdeckung/polished, with cover	<b>220,00</b>	<b>301807331</b>
	gebürstet, ohne Abdeckung/matt, without cover	<b>189,00</b>	<b>301907332</b>
	gebürstet, mit Abdeckung/matt, with cover	<b>229,00</b>	<b>301807332</b>
	weiß, ohne Abdeckung/white, without cover	<b>125,00</b>	<b>301907334</b>
	weiß, mit Abdeckung/white, with cover	<b>167,00</b>	<b>301807333</b>

**Brausehalter**  
Shower holder

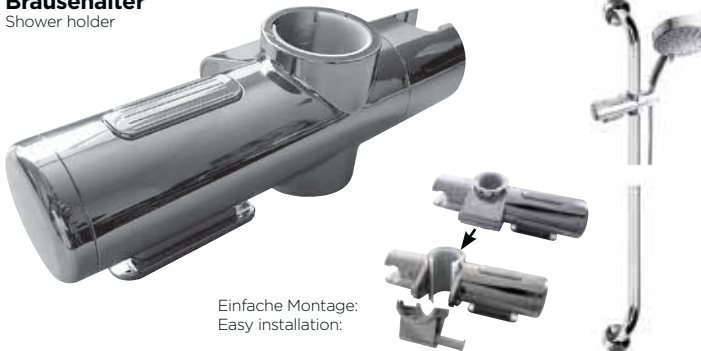

Einfache Montage:  
Easy installation:



Kann für die folgenden Produkte verwendet werden/Can be used for:

**Wannengriff:**

Grab bar:

500 mm	301100501,2,4,3	890 mm	301122041,2,4,3
600 mm	301100601,2,4,3		301112041,2,4,3
700 mm	301100701,2,4,3	680 mm	301112061,2,4,3
800 mm	301100801,2,4,3		301112071,2,4,3
900 mm	301100901,2,4,3		
1000 mm	301101001,2,4,3		
1100 mm	301101101,2,4,3		301122021,2,4,3
1200 mm	301101201,2,4,3		301112021,2,4,3
1500 mm	301101501,2,4,3		

Ausführung Finish	Preis Price	Bestellnummer Ordering number
Kunststoff, chrom/plastic, chrome	<b>79,00</b>	<b>338514372</b>
Kunststoff, weiß/plastic, chrome	<b>77,00</b>	<b>338514374</b>
Kunststoff, schwarz/plastic, chrome	<b>77,00</b>	<b>338514374</b>

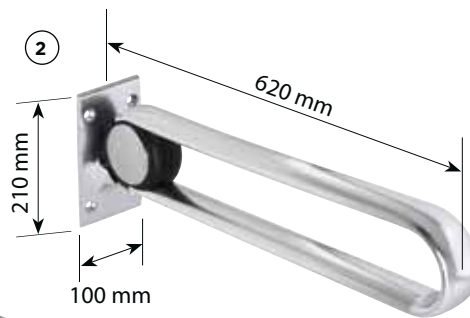
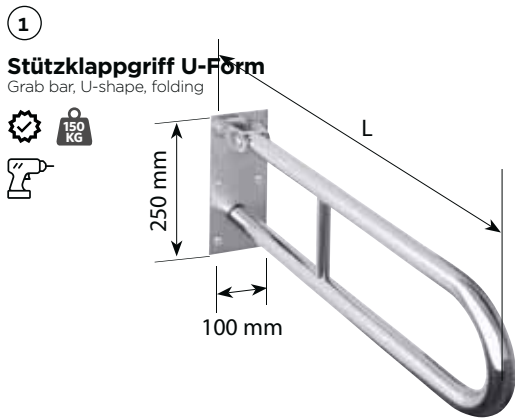

Längen der Wannengriffe [L] Product length [L]	Ausführung Finish	Preis € Price €	Bestellnummer Ordering number
① 600 mm	poliert, ohne Abdeckung/polished, without cover	197,00	301102071
	poliert, mit Abdeckung/polished, with cover	243,00	301607271
	gebürstet, ohne Abdeckung/matt, without cover	212,00	301102072
	gebürstet, mit Abdeckung/matt, with cover	237,00	301607272
	weiß, ohne Abdeckung/white, without cover	95,00	301102074
	weiß, mit Abdeckung/white, with cover	149,00	301607273
	schwarz mit Abdeckung/black with cover	149,00	301607270
750 mm	poliert, ohne Abdeckung/polished, without cover	213,00	301606301
	poliert, mit Abdeckung/polished, with cover	251,00	301607301
	gebürstet, ohne Abdeckung/matt, without cover	231,00	301606302
	gebürstet, mit Abdeckung/matt, with cover	242,00	301607302
	weiß, ohne Abdeckung/white, without cover	135,00	301606304
	weiß, mit Abdeckung/white, with cover	154,00	301607303
813 mm	poliert, ohne Abdeckung/polished, without cover	214,00	301102081
	poliert, mit Abdeckung/polished, with cover	257,00	301607471
	gebürstet, ohne Abdeckung/matt, without cover	231,00	301102082
	gebürstet, mit Abdeckung/matt, with cover	252,00	301607472
	weiß, ohne Abdeckung/white, without cover	108,00	301102084
	weiß, mit Abdeckung/white, with cover	139,00	301607473
850 mm	poliert, ohne Abdeckung/polished, without cover	234,00	301606321
	poliert, mit Abdeckung/polished, with cover	262,00	301607321
	gebürstet, ohne Abdeckung/matt, without cover	247,00	301606322
	gebürstet, mit Abdeckung/matt, with cover	262,00	301607322
	weiß, ohne Abdeckung/white, without cover	125,00	301606324
	weiß, mit Abdeckung/white, with cover	148,00	301607323
900 mm	poliert, ohne Abdeckung/polished, without cover	225,00	301102901
	poliert, mit Abdeckung/polished, with cover	263,00	301607331
	gebürstet, ohne Abdeckung/matt, without cover	236,00	301102902
	gebürstet, mit Abdeckung/matt, with cover	263,00	301607332
	weiß, ohne Abdeckung/white, without cover	126,00	301102904
	weiß, mit Abdeckung/white, with cover	143,00	301607333
②	Aluminium, poliert/aluminium, polished	584,00	355107272
③	Aluminium, schwarz/aluminium, black	584,00	355107270



1

**Stützklappgriff U-Form mit Toilettenpapierhalter**

Grab bar, U-shape, with toilet paper holder, folding

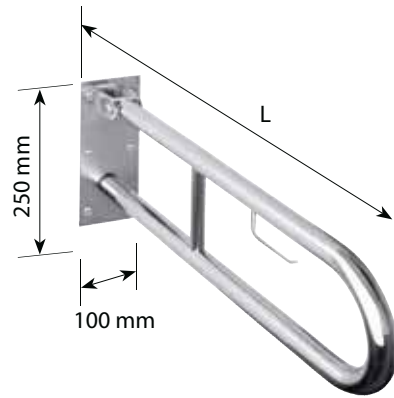

2

**Stützklappgriff U-Form, mit Arretierung, bodenmontiert**

Grab bar, U-shape, folding, with lock, floor-mounted

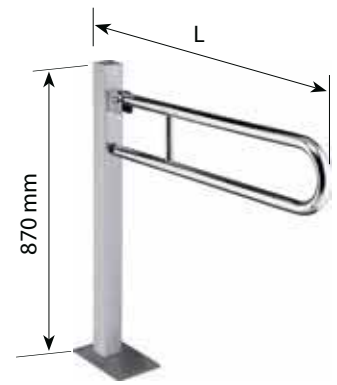
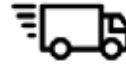

Längen der Wannengriffe [L] Product length [L]	Ausführung Finish	Preis € Price €	Bestellnummer Ordering number	
1 600 mm	poliert, ohne Abdeckung/polished, without cover	229,00	301102271	
	poliert, mit Abdeckung/polished, with cover	256,00	301407271	
	gebürstet, ohne Abdeckung/matt, without cover	245,00	301406272	
	gebürstet, mit Abdeckung/matt, with cover	265,00	301407272	
	weiß, ohne Abdeckung/white, without cover	136,00	301406274	
	weiß, mit Abdeckung/white, with cover	151,00	301407273	
	750 mm	poliert, ohne Abdeckung/polished, without cover	234,00	301406301
		poliert, mit Abdeckung/polished, with cover	265,00	301407301
		gebürstet, ohne Abdeckung/matt, without cover	249,00	301406302
		gebürstet, mit Abdeckung/matt, with cover	275,00	301407302
		weiß, ohne Abdeckung/white, without cover	137,00	301406304
		weiß, mit Abdeckung/white, with cover	161,00	301407303
	813 mm	poliert, ohne Abdeckung/polished, without cover	236,00	301102281
		poliert, mit Abdeckung/polished, with cover	275,00	301407281
gebürstet, ohne Abdeckung/matt, without cover		252,00	301102282	
gebürstet, mit Abdeckung/matt, with cover		284,00	301407282	
weiß, ohne Abdeckung/white, without cover		139,00	301102284	
weiß, mit Abdeckung/white, with cover		170,00	301407283	
850 mm	poliert, ohne Abdeckung/polished, without cover	246,00	301406321	
	poliert, mit Abdeckung/polished, with cover	284,00	301407321	
	gebürstet, ohne Abdeckung/matt, without cover	241,00	301406322	
	gebürstet, mit Abdeckung/matt, with cover	294,00	301407322	
	weiß, ohne Abdeckung/white, without cover	151,00	301406324	
	weiß, mit Abdeckung/white, with cover	180,00	301407323	
900 mm	poliert, ohne Abdeckung/polished, without cover	247,00	301102291	
	poliert, mit Abdeckung/polished, with cover	284,00	301407291	
	gebürstet, ohne Abdeckung/matt, without cover	262,00	301102292	
	gebürstet, mit Abdeckung/matt, with cover	294,00	301407292	
	weiß, ohne Abdeckung/white, without cover	137,00	301102294	
	weiß, mit Abdeckung/white, with cover	159,00	301407293	
2 750 mm	poliert, ohne Rosette/polished, without cover	405,00	301107301	
	poliert, mit Rosette/polished, with cover	453,00	301507301	
	gebürstet, ohne Rosette/matt, without cover	438,00	301107302	
	gebürstet, mit Rosette/matt, with cover	463,00	301507302	
	weiß, ohne Rosette/white, without cover	272,00	301107304	
	weiß, mit Rosette/white, with cover	329,00	301507303	
	813 mm	poliert, ohne Rosette/polished, without cover	415,00	301107601
		poliert, mit Rosette/polished, with cover	463,00	301507601
		gebürstet, ohne Rosette/matt, without cover	448,00	301107602
		gebürstet, mit Rosette/matt, with cover	472,00	301507602
		weiß, ohne Rosette/white, without cover	281,00	301107604
		weiß, mit Rosette/white, with cover	339,00	301507603
	850 mm	poliert, ohne Rosette/polished, without cover	424,00	301107321
		poliert, mit Rosette/polished, with cover	463,00	301507321
gebürstet, ohne Rosette/matt, without cover		457,00	301107322	
gebürstet, mit Rosette/matt, with cover		472,00	301507322	
weiß, ohne Rosette/white, without cover		291,00	301107324	
weiß, mit Rosette/white, with cover		339,00	301507323	

1

**Stützklappgriff U-Form abnehmbar mit Arretierung**

Grab bar, U-shape, folding, removable, with lock

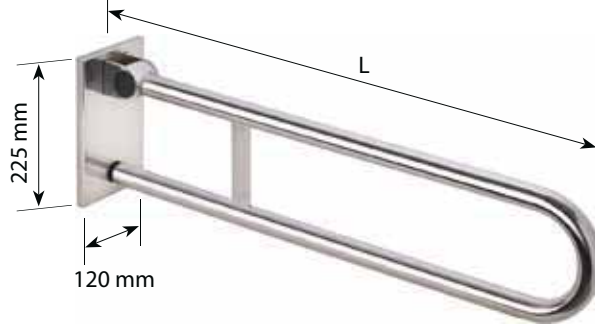

2

**Abdeckkappe für Ankerplatte**

Anchor plate cover

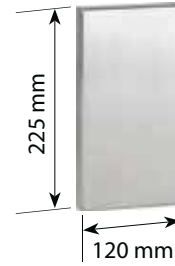

Längen der Wannengriffe [L] Product length [L]	Ausführung Finish	Preis € Price €	Bestellnummer Ordering number
600 mm	polished, with cover/poliert, mit Rosette	230,00	301507821
	matt, with cover/gebürstet, mit Rosette	223,00	301507825
813 mm	polished, with cover/poliert, mit Rosette	259,00	301507831
	matt, with cover/gebürstet, mit Rosette	248,00	301507835

2

Für Haltegriff For grab bar	Ausführung Finish	Preis Price	Bestellnummer Ordering number
301507821, 301507831	polished/poliert	28,00	301507841
301507825, 301507835	matt/gebürstet	28,00	301507845

3

**Stützklappgriff U-Form mit Arretierung**

Grab bar, U-shape, folding, with lock

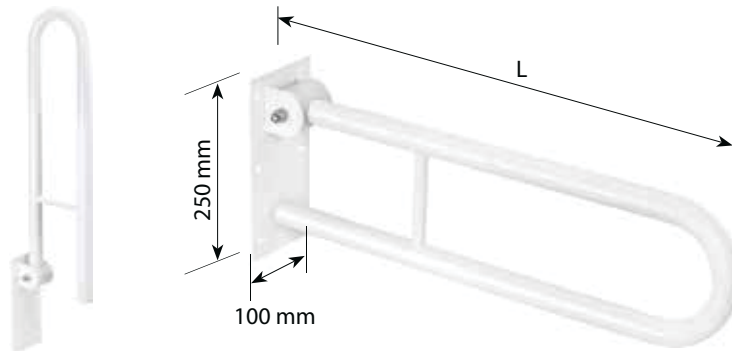

Längen der Wannengriffe [L] Product length [L]	Ausführung Finish	Preis € Price €	Bestellnummer Ordering number
600 mm	weiß, ohne Rosette/white, without cover	99,00	301507804
800 mm	weiß, ohne Rosette/white, without cover	103,00	301507814

4

**Türgriff**

Door handle

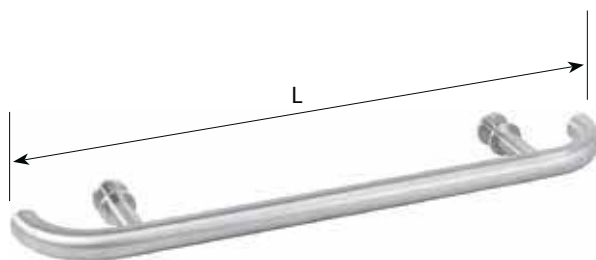

Längen der Wannengriffe [L] Product length [L]	Ausführung Finish	Preis € Price €	Bestellnummer Ordering number
700 mm	Edelstahl matt/stainless steel matt	87,00	301553015
	weiß/white	79,00	301553014
	schwarz/black	79,00	301553010
800 mm	Edelstahl matt/stainless steel matt	93,00	301553025
	weiß/white	83,00	301553024
	schwarz/black	83,00	301553020

1

**Stützklappgriff U-Form mit Bodenstütze**

Grab bar, U-shape, folding, with support leg

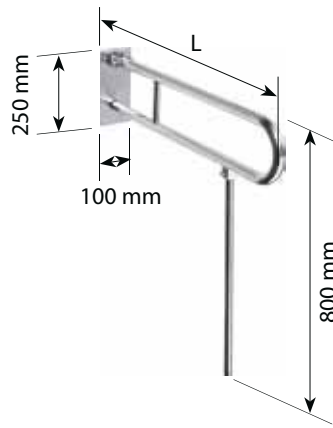

2

**Stützklappgriff U-Form mit Bodenstütze und Toilettenpapierhalter**

Grab bar, U-shape, folding, with support leg, with toilet paper holder



Längen der Wannengriffe [L] Product length [L]	Ausführung Finish	Preis € Price €	Bestellnummer Ordering number	
1 600 mm	poliert, ohne Rosette/polished, without cover	229,00	301102071N	
	poliert, mit Rosette/polished, with cover	282,00	301307071N	
	gebürstet, ohne Rosette/matt, without cover	246,00	301102072N	
	gebürstet, mit Rosette/matt, with cover	283,00	301307072N	
	weiß, ohne Rosette/white, without cover	129,00	301102074N	
	weiß, mit Rosette/white, with cover	164,00	301307073N	
	750 mm	poliert, ohne Rosette/polished, without cover	229,00	301606301N
		poliert, mit Rosette/polished, with cover	276,00	301307301N
		gebürstet, ohne Rosette/matt, without cover	249,00	301606302N
		gebürstet, mit Rosette/matt, with cover	285,00	301307302N
		weiß, ohne Rosette/white, without cover	134,00	301606304N
		weiß, mit Rosette/white, with cover	164,00	301307303N
813 mm	poliert, ohne Rosette/polished, without cover	249,00	301102081N	
	poliert, mit Rosette/polished, with cover	284,00	301307081N	
	gebürstet, ohne Rosette/matt, without cover	260,00	301102082N	
	gebürstet, mit Rosette/matt, with cover	284,00	301307082N	
	weiß, ohne Rosette/white, without cover	178,00	301102084N	
	weiß, mit Rosette/white, with cover	214,00	301307083N	
850 mm	poliert, ohne Rosette/polished, without cover	254,00	301606321N	
	poliert, mit Rosette/polished, with cover	294,00	301307321N	
	gebürstet, ohne Rosette/matt, without cover	264,00	301606322N	
	gebürstet, mit Rosette/matt, with cover	299,00	301307322N	
	weiß, ohne Rosette/white, without cover	151,00	301606324N	
	weiß, mit Rosette/white, with cover	184,00	301307323N	
2 600 mm	poliert, ohne Rosette/polished, without cover	249,00	301102271N	
	poliert, mit Rosette/polished, with cover	298,00	301407271N	
	gebürstet, ohne Rosette/matt, without cover	272,00	301406272N	
	gebürstet, mit Rosette/matt, with cover	310,00	301407272N	
	weiß, ohne Rosette/white, without cover	155,00	301406274N	
	weiß, mit Rosette/white, with cover	208,00	301407273N	
	750 mm	poliert, ohne Rosette/polished, without cover	256,00	301406301N
		poliert, mit Rosette/polished, with cover	304,00	301407301N
		gebürstet, ohne Rosette/matt, without cover	273,00	301406302N
		gebürstet, mit Rosette/matt, with cover	313,00	301407302N
		weiß, ohne Rosette/white, without cover	161,00	301406304N
		weiß, mit Rosette/white, with cover	197,00	301407303N
813 mm	poliert, ohne Rosette/polished, without cover	254,00	301102281N	
	poliert, mit Rosette/polished, with cover	317,00	301407281N	
	gebürstet, ohne Rosette/matt, without cover	271,00	301102282N	
	gebürstet, mit Rosette/matt, with cover	332,00	301407282N	
	weiß, ohne Rosette/white, without cover	158,00	301102284N	
	weiß, mit Rosette/white, with cover	218,00	301407283N	
850 mm	poliert, ohne Rosette/polished, without cover	273,00	301406321N	
	poliert, mit Rosette/polished, with cover	320,00	301407321N	
	gebürstet, ohne Rosette/matt, without cover	276,00	301406322N	
	gebürstet, mit Rosette/matt, with cover	332,00	301407322N	
	weiß, ohne Rosette/white, without cover	167,00	301406324N	
	weiß, mit Rosette/white, with cover	219,00	301407323N	

1

**Stützklappgriff**

Grab bar, folding

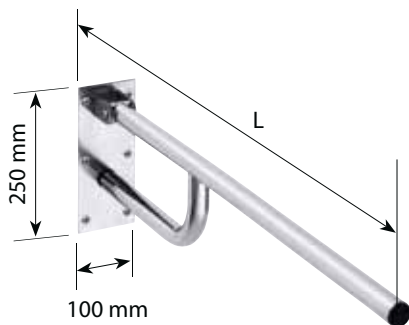

2

**Stützklappgriff mit Toilettenpapierhalter**

Grab bar, with toilet paper holder, folding



Längen der Wannengriffe [L] Product length [L]	Ausführung Finish	Preis € Price €	Bestellnummer Ordering number
1 760 mm	poliert, ohne Rosette/polished, without cover	199,00	301102091
	poliert, mit Rosette/polished, with cover	239,00	301607091
	gebürstet, ohne Rosette/matt, without cover	200,00	301102092
	gebürstet, mit Rosette/matt, with cover	248,00	301607092
	weiß, ohne Rosette/white, without cover	111,00	301102094
	weiß, mit Rosette/white, with cover	148,00	301607093
850 mm	poliert, ohne Rosette/polished, without cover	221,00	301102321
	poliert, mit Rosette/polished, with cover	244,00	301607161
	gebürstet, ohne Rosette/matt, without cover	234,00	301102322
	gebürstet, mit Rosette/matt, with cover	251,00	301607162
	weiß, ohne Rosette/white, without cover	118,00	301102324
	weiß, mit Rosette/white, with cover	155,00	301607163

2 760 mm	poliert, ohne Rosette/polished, without cover	219,00	301102771
	poliert, mit Rosette/polished, with cover	266,00	301607771
	gebürstet, ohne Rosette/matt, without cover	233,00	301102772
	gebürstet, mit Rosette/matt, with cover	276,00	301607772
	weiß, ohne Rosette/white, without cover	129,00	301102774
	weiß, mit Rosette/white, with cover	176,00	301607773
850 mm	poliert, ohne Rosette/polished, without cover	245,00	301102781
	poliert, mit Rosette/polished, with cover	271,00	301607781
	gebürstet, ohne Rosette/matt, without cover	262,00	301102782
	gebürstet, mit Rosette/matt, with cover	278,00	301607782
	weiß, ohne Rosette/white, without cover	126,00	301102784
	weiß, mit Rosette/white, with cover	182,00	301607783

3

**Winkelgriff 120°**

Grab bar, angular 120°

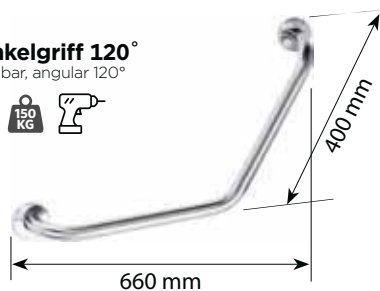

4

**Duschhandlauf**

Grab bar, corner

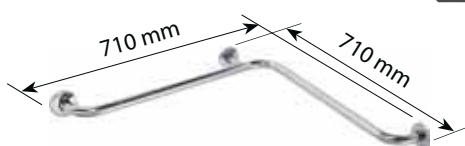

5

**Siphonschutz**

Protection of dip-pipe against wheelchair crash

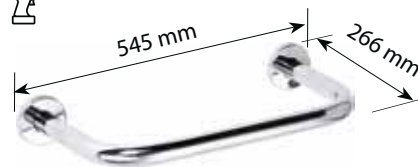

3 660×400 mm	poliert, mit Rosette/polished, with cover	121,00	301102011
	gebürstet, mit Rosette/matt, with cover	118,00	301102012
	weiß, ohne Rosette/white, without cover	91,00	301102014
	weiß, mit Rosette/white, with cover	96,00	301102013

4 710×710 mm	poliert, mit Rosette/polished, with cover	191,00	301102031
	gebürstet, mit Rosette/matt, with cover	198,00	301102032
	weiß, ohne Rosette/white, without cover	93,00	301102034
	weiß, mit Rosette/white, with cover	123,00	301102033

5 545×266 mm	poliert, mit Rosette/polished, with cover	100,00	301102121
	gebürstet, mit Rosette/matt, with cover	109,00	301102122
	weiß, ohne Rosette/white, without cover	57,00	301102124
	weiß, mit Rosette/white, with cover	83,00	301102123

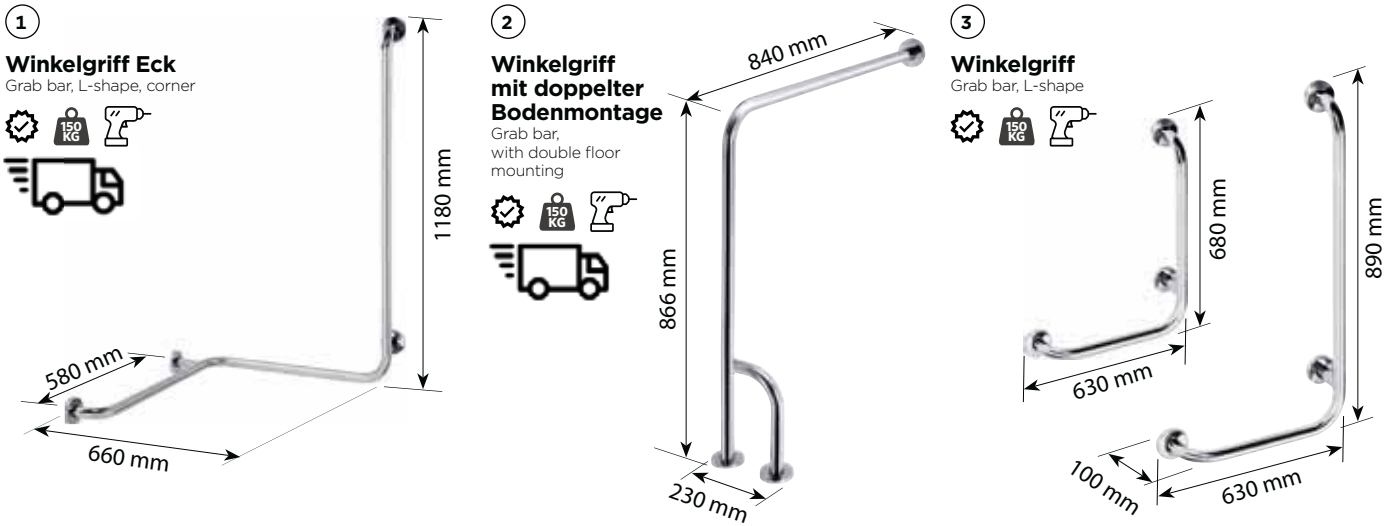

Längen der Wannengriffe [L] Product length [L]	Ausführung Finish	Preis € Price €	Bestellnummer Ordering number	
<b>1</b>	<b>rechts/right</b>	poliert, mit Rosette/polished, with cover	<b>259,00</b>	<b>301122021</b>
		gebürstet, mit Rosette/matt, with cover	<b>268,00</b>	<b>301122022</b>
		weiß, ohne Rosette/white, without cover	<b>173,00</b>	<b>301122024</b>
		weiß, mit Rosette/white, with cover	<b>186,00</b>	<b>301122023</b>
	<b>links/left</b>	poliert, mit Rosette/polished, with cover	<b>260,00</b>	<b>301112021</b>
		gebürstet, mit Rosette/matt, with cover	<b>269,00</b>	<b>301112022</b>
		weiß, ohne Rosette/white, without cover	<b>173,00</b>	<b>301112024</b>
		weiß, mit Rosette/white, with cover	<b>186,00</b>	<b>301112023</b>
<b>2</b>	<b>rechts/right</b>	poliert, mit Rosette/polished, with cover	<b>267,00</b>	<b>301122141</b>
		gebürstet, mit Rosette/matt, with cover	<b>279,00</b>	<b>301122142</b>
		weiß, ohne Rosette/white, without cover	<b>128,00</b>	<b>301122144</b>
		weiß, mit Rosette/white, with cover	<b>164,00</b>	<b>301122143</b>
	<b>links/left</b>	poliert, mit Rosette/polished, with cover	<b>267,00</b>	<b>301112131</b>
		gebürstet, mit Rosette/matt, with cover	<b>289,00</b>	<b>301112132</b>
		weiß, ohne Rosette/white, without cover	<b>131,00</b>	<b>301112134</b>
		weiß, mit Rosette/white, with cover	<b>164,00</b>	<b>301112133</b>
<b>3</b>	<b>rechts/right</b>	poliert, mit Rosette/polished, with cover	<b>192,00</b>	<b>301122041</b>
	<b>890 mm</b>	gebürstet, mit Rosette/matt, with cover	<b>198,00</b>	<b>301122042</b>
		weiß, ohne Rosette/white, without cover	<b>125,00</b>	<b>301122044</b>
		weiß, mit Rosette/white, with cover	<b>157,00</b>	<b>301122043</b>
		schwarz mit Rosette/black with cover	<b>157,00</b>	<b>301122040</b>
	<b>links/left</b>	poliert, mit Rosette/polished, with cover	<b>190,00</b>	<b>301112041</b>
	<b>890 mm</b>	gebürstet, mit Rosette/matt, with cover	<b>197,00</b>	<b>301112042</b>
		weiß, ohne Rosette/white, without cover	<b>125,00</b>	<b>301112044</b>
		weiß, mit Rosette/white, with cover	<b>157,00</b>	<b>301112043</b>
		schwarz mit Rosette/black with cover	<b>157,00</b>	<b>301122040</b>
	<b>rechts/right</b>	poliert, mit Rosette/polished, with cover	<b>184,00</b>	<b>301112061</b>
	<b>680 mm</b>	gebürstet, mit Rosette/matt, with cover	<b>197,00</b>	<b>301112062</b>
		weiß, ohne Rosette/white, without cover	<b>125,00</b>	<b>301112064</b>
		weiß, mit Rosette/white, with cover	<b>151,00</b>	<b>301112063</b>
	<b>links/left</b>	poliert, mit Rosette/polished, with cover	<b>184,00</b>	<b>301112071</b>
	<b>680 mm</b>	gebürstet, mit Rosette/matt, with cover	<b>198,00</b>	<b>301112072</b>
		weiß, ohne Rosette/white, without cover	<b>125,00</b>	<b>301112074</b>
		weiß, mit Rosette/white, with cover	<b>151,00</b>	<b>301112073</b>

1

**Winkelgriff Eck steckbar/zerlegt**

Grab bar, L-shape, corner, folding

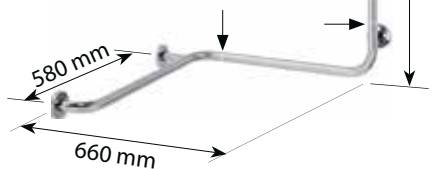

2

**Winkelgriff mit doppelter Bodenmontage steckbar/zerlegt**

Grab bar, with double floor mounting, folding



3

**Duschhandlauf steckbar/zerlegt**

Grab bar, corner, folding

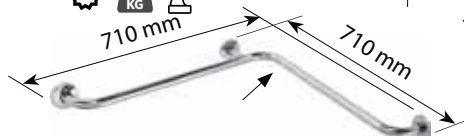

4

**Winkelgriff steckbar/zerlegt**

Grab bar, L-shape, folding

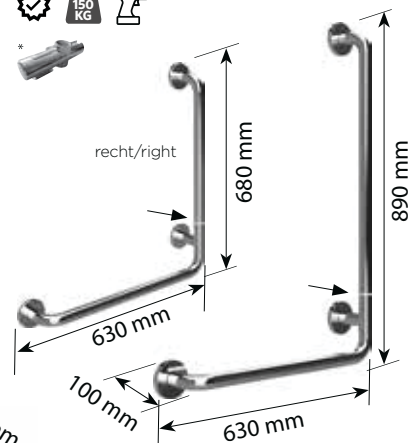

Längen der Wannengriffe [L] Product length [L]	Ausführung Finish	Preis € Price €	Bestellnummer Ordering number	
1	<b>rechts/right</b>	poliert, mit Rosette/polished, with cover	259,00	301153021
		gebürstet, mit Rosette/matt, with cover	268,00	301153022
		weiß, ohne Rosette/white, without cover	186,00	301153023
		weiß, mit Rosette/white, with cover	173,00	301153024
	<b>links/left</b>	poliert, mit Rosette/polished, with cover	260,00	301154021
		gebürstet, mit Rosette/matt, with cover	269,00	301154022
		weiß, ohne Rosette/white, without cover	186,00	301154023
		weiß, mit Rosette/white, with cover	173,00	301154024
2	<b>rechts/right</b>	poliert, mit Rosette/polished, with cover	267,00	301153141
		gebürstet, mit Rosette/matt, with cover	279,00	301153142
		weiß, ohne Rosette/white, without cover	164,00	301153143
		weiß, mit Rosette/white, with cover	128,00	301153144
	<b>links/left</b>	poliert, mit Rosette/polished, with cover	267,00	301154131
		gebürstet, mit Rosette/matt, with cover	289,00	301154132
		weiß, ohne Rosette/white, without cover	164,00	301154133
		weiß, mit Rosette/white, with cover	131,00	301154134
3	<b>710×710 mm</b>	poliert, mit Rosette/polished, with cover	191,00	301153031
		gebürstet, mit Rosette/matt, with cover	198,00	301153032
		weiß, ohne Rosette/white, without cover	123,00	301153033
		weiß, mit Rosette/white, with cover	93,00	301153034
4	<b>rechts/right</b>	poliert, mit Rosette/polished, with cover	184,00	301153061
	<b>680 mm</b>	gebürstet, mit Rosette/matt, with cover	197,00	301153062
		weiß, ohne Rosette/white, without cover	151,00	301153063
		weiß, mit Rosette/white, with cover	125,00	301153064
	<b>links/left</b>	poliert, mit Rosette/polished, with cover	184,00	301154071
	<b>680 mm</b>	gebürstet, mit Rosette/matt, with cover	198,00	301154072
		weiß, ohne Rosette/white, without cover	151,00	301154073
		weiß, mit Rosette/white, with cover	125,00	301154074
	<b>rechts/right</b>	poliert, mit Rosette/polished, with cover	192,00	301153041
	<b>890 mm</b>	gebürstet, mit Rosette/matt, with cover	198,00	301153042
		weiß, ohne Rosette/white, without cover	157,00	301153043
		weiß, mit Rosette/white, with cover	125,00	301153044
	<b>links/left</b>	poliert, mit Rosette/polished, with cover	190,00	301154041
	<b>890 mm</b>	gebürstet, mit Rosette/matt, with cover	197,00	301154042
		weiß, ohne Rosette/white, without cover	157,00	301154043
		weiß, mit Rosette/white, with cover	125,00	301154044

1

**Stützgriff mit 3-Punkt  
Wandmontage**

Grab bar, with double mounting

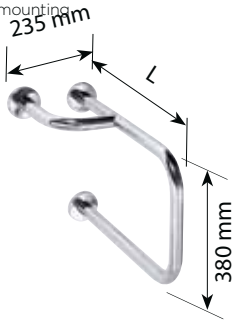

2

**Griff**

Handle with shelf



Längen der Wannengriffe [L] Product length [L]	Ausführung Finish	Preis € Price €	Bestellnummer Ordering number
<b>rechts/right</b>	poliert, mit Rosette/polished, with cover	<b>201,00</b>	<b>301122111</b>
<b>500 mm</b>	gebürstet, mit Rosette/matt, with cover	<b>217,00</b>	<b>301122112</b>
	weiß, ohne Rosette/white, without cover	<b>108,00</b>	<b>301122114</b>
	weiß, mit Rosette/white, with cover	<b>146,00</b>	<b>301122113</b>
<b>links/left</b>	poliert, mit Rosette/polished, with cover	<b>201,00</b>	<b>301112101</b>
<b>500 mm</b>	gebürstet, mit Rosette/matt, with cover	<b>217,00</b>	<b>301112102</b>
	weiß, ohne Rosette/white, without cover	<b>108,00</b>	<b>301112104</b>
	weiß, mit Rosette/white, with cover	<b>146,00</b>	<b>301112103</b>
<b>rechts/right</b>	poliert, mit Rosette/polished, with cover	<b>237,00</b>	<b>301112161</b>
<b>760 mm</b>	gebürstet, mit Rosette/matt, with cover	<b>255,00</b>	<b>301112162</b>
	weiß, ohne Rosette/white, without cover	<b>130,00</b>	<b>301112164</b>
	weiß, mit Rosette/white, with cover	<b>161,00</b>	<b>301112163</b>
<b>links/left</b>	poliert, mit Rosette/polished, with cover	<b>237,00</b>	<b>301112151</b>
<b>760 mm</b>	gebürstet, mit Rosette/matt, with cover	<b>255,00</b>	<b>301112152</b>
	weiß, ohne Rosette/white, without cover	<b>130,00</b>	<b>301112154</b>
	weiß, mit Rosette/white, with cover	<b>161,00</b>	<b>301112153</b>
<b>580×220 mm</b>	poliert, mit Rosette/polished, with cover	<b>163,00</b>	<b>301100571</b>
	gebürstet, mit Rosette/matt, with cover	<b>174,00</b>	<b>301100572</b>
	weiß, ohne Rosette/white, without cover	<b>98,00</b>	<b>301100574</b>
	weiß, mit Rosette/white, with cover	<b>107,00</b>	<b>301100573</b>

**Barrierefreie Bäder.**

Ausführung: Edelstahl poliert, Edelstahl gebürstet, Pulverbeschichtet weiß. Lösung für sichere Bewegung und Hygiene. Große Variabilität von Formen und Abmessungen. Hohe Produktqualität, Zertifikate verfügbar.

**Bathroom accessories for safe movement in your bathroom.**

Finish: stainless steel polished, stainless steel brushed, steel powder coated white. Wide variability of shapes and dimensions. High product quality demonstrated by certificates.

Die mit diesem Symbol  gekennzeichneten Produkte für barrierefreies Wohnen aus dem HELP-Katalog wurden auf eine Belastbarkeit von 150 kg getestet und zertifiziert. Der Hersteller übernimmt jedoch keine Gewährleistung für die Montage oder die Tragfähigkeit der Wand oder des Untergrundes, an dem das Produkt befestigt wird. Die korrekte Befestigung und die Beurteilung des Montageuntergrundes liegen im Verantwortungsbereich des Installateurs oder Endnutzers.

Products marked with this icon  for barrier-free living from the HELP catalogue are tested and certified for a load capacity of 150 kg. However, the manufacturer is not liable for the installation or the load-bearing capacity of the wall or other surface to which the product is attached – proper installation and assessment of the wall substrate is the responsibility of the installer or user.

1

**Abdeckplatte für Türmontage**

Back cover for mounting on door



2

**Duschklapsitz zur Wandmontage**

Shower seat, folding



3

**Duschklapsitz zur Wandmontage**

Shower seat, folding



4

**UP-Modul zur Befestigung des Duschklapsitzes 347125011**

Construction for fixing in plasterboard shower seat 347125011



1	Ausführung Finish	Preis € Price €	Bestellnummer Ordering number
	poliert/polished	36,00	131567174
	gebürstet/matt	36,00	131567175
2	Aluminium, Kunststoff/aluminium, plastic	457,00	355125037
3	Edelstahl, Kunststoff/stainless steel, plastic	409,00	347125011
	schwarz, Kunststoff/black, plastic	412,00	347125010
4	Stahl/steel	164,00	347625051

5

**Duschklapsitz zur Wandmontage mit klappbarer Bodenstütze**

Shower seat, folding, with leg



6

**Duschklapsitz zur Wandmontage mit klappbarer Bodenstütze**

Shower seat, folding, with leg



7

**Duschklapsitz zur Wandmontage**

Shower seat, folding



	Ausführung Finish	Preis € Price €	Bestellnummer Ordering number
5	Aluminium, Kunststoff/aluminium, plastic	172,00	353125033
6	poliert, ohne Rosette/polished, without cover	321,00	301102181
	poliert, mit Rosette/polished, with cover	353,00	301207181
	weiß, ohne Rosette/white, without cover	338,00	301102182
	gebürstet, mit Rosette/matt, with cover	371,00	301207182
	weiß, ohne Rosette/white, without cover	383,00	301102184
	weiß, mit Rosette/white, with cover	404,00	301207183
	schwarz, mit Rosette/black, with cover	383,00	301102180
7	Edelstahl, Kunststoff/stainless steel, plastic	197,00	326325056



Ausführung Finish	Preis € Price €	Bestellnummer Ordering number
<b>1</b> Edelstahl, Kunststoff/stainless steel, plastic	249,00	338125066
<b>2</b> Edelstahl, weißer Kunststoff /stainless steel, white plastic	333,00	338125081
Edelstahl, schwarzer Kunststoff/stainless steel, black plastic	333,00	338125080
<b>3</b> Edelstahl, Kunststoff/stainless steel, plastic	340,00	338125071
<b>4</b> Aluminium, Kunststoff/aluminium, plastic	121,00	353125043
<b>5</b> Aluminium, Kunststoff/aluminium, plastic	172,00	353125103
<b>6</b> Aluminium, Kunststoff/aluminium, plastic	172,00	353125123
<b>7</b> Aluminium, Kunststoff/aluminium, plastic	192,00	353125113

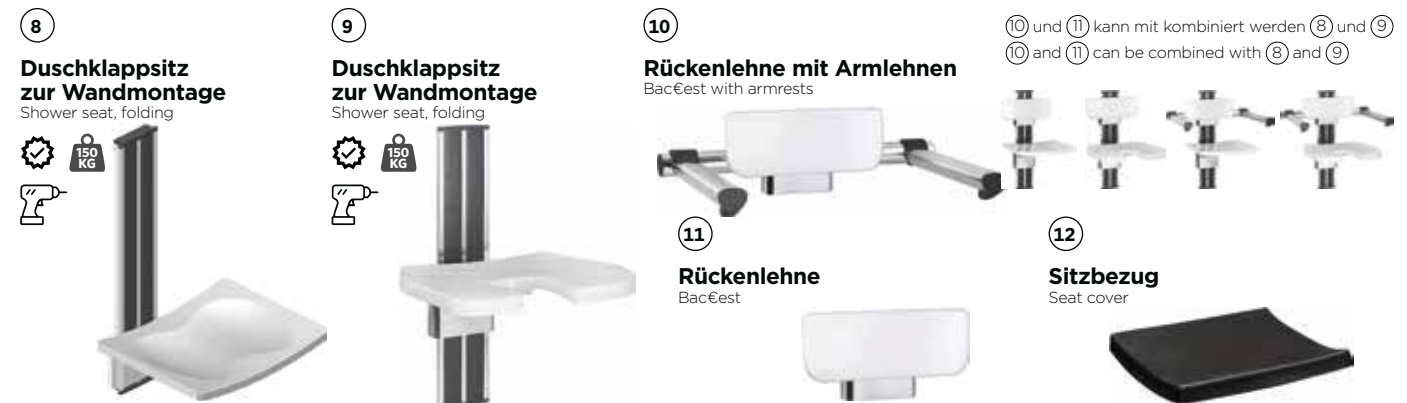

Ausführung Finish	Preis € Price €	Bestellnummer Ordering number
<b>8</b> Edelstahl, Kunststoff/stainless steel, plastic	781,00	355125177
<b>9</b> Edelstahl, Kunststoff/stainless steel, plastic	924,00	355125147
<b>10</b> Edelstahl, Kunststoff/stainless steel, plastic	680,00	355125167
<b>11</b> Aluminium, Kunststoff/aluminium, plastic	286,00	355125157
<b>12</b> Gummi/rubber	164,00	355125170

1

**Kippspiegel**

Tilting mirror

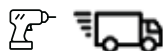

2

**Kippspiegel**

Tilting mirror

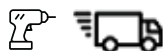

Abmessungen Dimension	Ausführung Finish	Preis € Price €	Bestellnummer Ordering number
<b>1</b> 600×400 mm	poliert/polished	299,00	301401031
	gebürstet/matt	318,00	301401032
	weiß/white	198,00	301401034
	schwarz/black	199,00	301401030
<b>2</b> 600×600 mm	poliert/polished	345,00	301401041
	gebürstet/matt	377,00	301401042
	weiß/white	234,00	301401044

3

**Kippspiegel mit LED Beleuchtung, Berührungssensor**

Tilting mirror with LED lighting, touch sensor

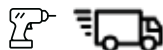

4

**Kippspiegel mit LED Beleuchtung, Berührungssensor**

Tilting mirror with LED lighting, touch sensor

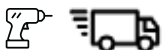

Abmessungen Dimension	Ausführung Finish	Preis € Price €	Bestellnummer Ordering number
<b>3</b> 400×600 mm	schwarz/black	525,00	301201030
	poliert/polished	611,00	301201031
	gebürstet/matt	557,00	301201035
	weiß/white	525,00	301201034
<b>4</b> 600×600 mm	schwarz/black	577,00	301201040
	poliert/polished	655,00	301201041
	gebürstet/matt	633,00	301201045
	weiß/white	577,00	301201044

5

**Bedienungshebel für kippbare Spiegel**

Handling lever for tilting mirrors

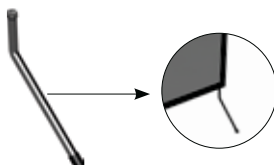

Ausführung Finish	Preis € Price €	Bestellnummer Ordering number
<b>5</b> schwarz/black	46,00	301501090
poliert/polished	52,00	301501091
gebürstet/matt	47,00	301501095
weiß/white	46,00	301501094

# VERWENDUNG VON HALTEGRIFFEN UND HALTEBÜGELN

USING SUPPORT HANDLES AND SUPPORT BRACKETS

## Unterstützung auf Treppen und an Türen

Support on stairs and at doors

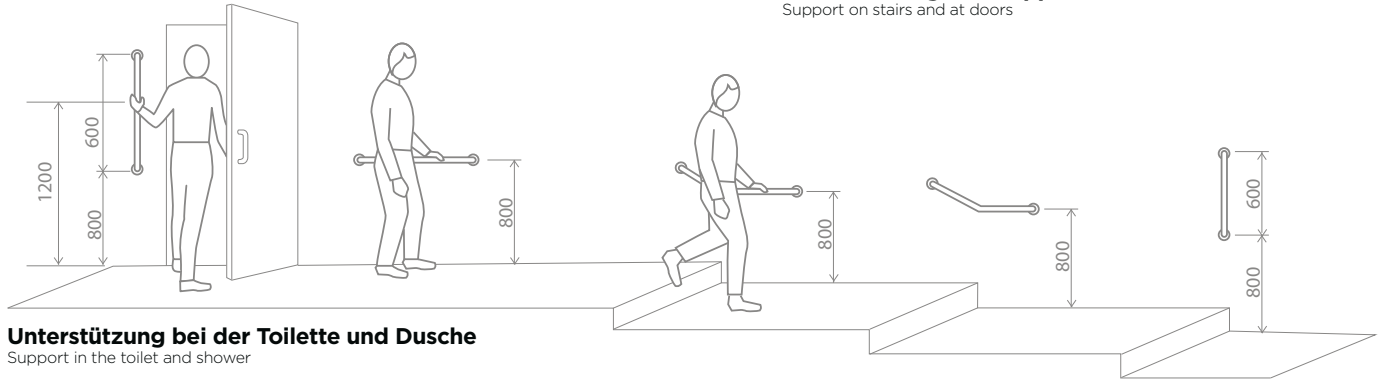





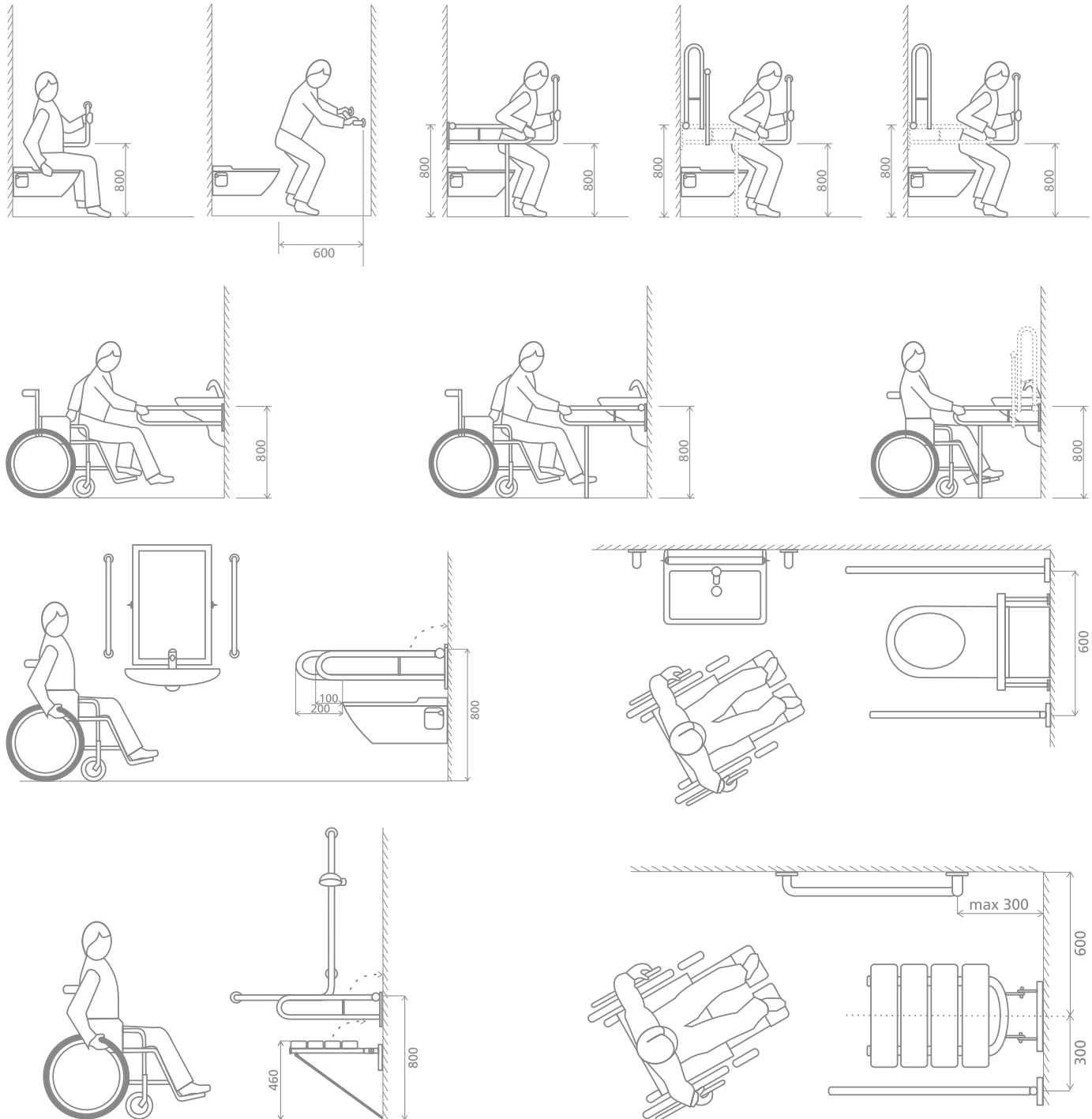









## Unterstützung bei der Toilette und Dusche























Support in the toilet and shower







































# ersatzteile

SPARE PARTS





















Produkt Product	Ersatzteil Spare part	Preis € Price €	Bestellnummer Ordering number
<b>AURIA / GLACERA</b>			
GLACERA 175113010	 Ersatz-WC Bürste mit Griff Spare WC brush with handle	35,00	131567848
AURIA 171113010	 Ersatz-WC Bürste mit Griff Spare WC brush with handle	35,00	131567847
175113010 171113010	 Ersatz-WC Bürste ohne Griff Spare WC brush without handle	10,00	131567008
175113010 171113010	 Glasschale für WC-Bürste Glass dish for WC brush	19,00	131567832
175108040 171108040	 Glasseifenschale, matt Glass soap dish, frosted	11,00	131567002m
175110010 171110010	 Glasbecher, matt Glass cup, frosted	11,00	131567001m
GLACERA 175109010	 Pumpe, komplett Spare pump, complete	55,50	131567841
AURIA 171109010	 Pumpe, komplett Spare pump, complete	55,50	131567840
<b>BRILIA / GRINO</b>			
BRILIA 177113010	 Ersatz-WC Bürste mit Griff Spare WC brush with handle	28,50	131567851
GRINO 173113010	 Ersatz-WC Bürste mit Griff Spare WC brush with handle	34,50	131567850
177113010 173113010	 Ersatz-WC Bürste ohne Griff Spare WC brush without handle	10,00	131567008
177113010 173113010	 Glasschale für WC-Bürste Glass dish for WC brush	19,00	131567832
177108040 173108040	 Glasseifenschale, matt Glass soap dish, frosted	11,00	131567002m
177110010 173110010	 Glasbecher, matt Glass cup, frosted	11,00	131567001m
BRILIA 177109010	 Pumpe, komplett Spare pump, complete	47,00	131567844
GRINO 173109010	 Pumpe, komplett Spare pump, complete	55,50	131567843
<b>ZYRA / COPRA</b>			
ZYRA 174113010	 Ersatz-WC Bürste mit Griff Spare WC brush with handle	35,00	131567847
COPRA 176113010	 Ersatz-WC Bürste mit Griff Spare WC brush with handle	34,50	131567849
174113010 176113010	 Ersatz-WC Bürste ohne Griff Spare WC brush without handle	10,00	131567008
174113010 176113010	 Glasschale für WC-Bürste Glass dish for WC brush	19,00	131567832
174108040 176108040	 Glasseifenschale, matt Glass soap dish, frosted	11,00	131567002m
174110010 176110010	 Glasbecher, matt Glass cup, frosted	11,00	131567001m













Produkt Product	Ersatzteil Spare part	Preis € Price €	Bestellnummer Ordering number
ZYRA 174109010	 Pumpe, komplett Spare pump, complete	55,50	131567840
COPRA 174109010	 Pumpe, komplett Spare pump, complete	55,50	131567842
<b>DELTA</b>			
181013012	 Ersatz-WC Bürste mit Griff Spare WC brush with handle	100,00	131567872
181013012	 Glasschale für WC-Bürste Glass dish for WC brush	85,00	131567871
181008022	 Glasseifenschale, matt Glass soap dish, frosted	65,00	131567877
181011012	 Glasbecher, matt Glass cup, frosted	60,00	131567839
181009042	 Glas für Seifenspender, matt Glass for soap dispenser, frosted	60,00	131567874
<b>NIA</b>			
180013015	 Ersatz-WC Bürste mit Griff Spare WC brush with handle	28,00	131567867
180913095	 Ersatz-WC Bürste ohne Griff Spare WC brush without handle	7,00	131567384c
180013015	 Glasschale für WC-Bürste Glass dish for WC brush	20,00	131567253
180008025	 Glasseifenschale, matt Glass soap dish, frosted	13,00	131567250
180011015	 Glasbecher, matt Glass cup, frosted	13,00	131567249
180009045	 Glas für Seifenspender, matt Glass for soap dispenser, frosted	19,00	131567251
180009045	 Pumpe, komplett Spare pump, complete	33,00	131567205
<b>ORGANIC / ORGANIC BLACK</b>			
ORGANIC 157113141	 Ersatz-WC Bürste mit Griff Spare WC brush with handle	30,00	131567650
ORGANIC BLACK 167113140	 Ersatz-WC Bürste mit Griff Spare WC brush with handle	33,00	131567754
ORGANIC 157113061	 Ersatz-WC Silikonbürste mit Griff mit Abdeckung Spare WC silicone brush incl. handle with vessel cover	41,00	131567655
ORGANIC BLACK 167113060	 Ersatz-WC Bürste mit Griff Spare WC brush with handle	26,00	131567758
ORGANIC 157113141	 Ersatz-WC Bürste ohne Griff Spare WC brush without handle	12,00	131567651
ORGANIC BLACK 167113140	 Ersatz-WC Silikonbürste ohne Griff Spare WC silicone brush without handle	7,00	131567755
157113061 167113060	 Ersatz-WC Bürste ohne Griff Spare WC brush without handle	8,00	131567656
157113141 167113140	 Glasschale für WC-Bürste Glass dish for WC brush	25,00	131567653









Produkt Product	Ersatzteil Spare part	Preis € Price €	Bestellnummer Ordering number	Produkt Product	Ersatzteil Spare part	Preis € Price €	Bestellnummer Ordering number
157111011 167111010	 <b>Glasbecher, matt</b> Glass cup, frosted	12,00	131567659	138709041 138109161	 <b>Ersatz-Glas für Seifenspender MINI mit Pumpe, matt</b> Glass for soap dispenser MINI with pump	27,00	131567147
157102241 167102240	 <b>Ersatz-Glas für Ablage</b> Glass for shelf	30,00	131567658	104019012 104109012 104109017 104109102 104109182	 <b>Ersatz-Pumpe für Seifenspender</b> Spare pump complete, chrome	32,00	131567204
157109261 157109271 167109260 167109270	 <b>Seifenspenderöffner</b> Soap dispenser key	4,00	131567791	104609172 138109161 138709041	 <b>Ersatz-Pumpe für Seifenspender</b> Spare pump	12,00	131567007
<b>GALLA</b>				104109032	 <b>Ersatz-Pumpe für Seifenspender</b> Spare pump complete, chrome	32,00	131567157
108113010	 <b>Ersatz-WC Bürste mit Griff</b> Spare WC brush with handle	26,00	131567446	104122042 104102202	 <b>Ersatz-Glas für Ablage, matt</b> Glass for shelf, frosted	23,00	131567111
108113010	 <b>Ersatz-WC Bürste ohne Griff</b> Spare WC brush without handle	10,00	131567008c	104102042 104102212	 <b>Ersatz-Glas für Ablage, matt</b> Glass for shelf, frosted	16,00	131567066
<b>OMEGA</b>				104102012	 <b>Ersatz-Glas für Ablage, Eckmodell, matt</b> Glass for corner shelf, frosted	16,00	131567047
104113012 104113102 104836012 104913092 104913112 104913122 104913152	 <b>Ersatz-WC Bürste mit Griff</b> Spare WC brush with handle	19,00	131567009	<b>NEO</b>			
104113107 104113017 104836012 104913092 104913117 104913122 104913152	 <b>Ersatz-WC Bürste mit Griff</b> Spare WC brush with handle	19,00	131567009c	102313065	 <b>Ersatz-WC Bürste mit Griff mit Abdeckung</b> Spare WC brush incl. handle with vessel cover	41,00	131567120
102313066 102313056	 <b>Ersatz-WC Bürste mit Griff mit Abdeckung</b> Spare WC brush incl. handle with vessel cover	39,00	131567054	102313069	 <b>Ersatz-WC Bürste mit Griff mit Abdeckung</b> Spare WC brush incl. handle with vessel cover	41,00	131567120c
102313067 102313057	 <b>Ersatz-WC Bürste mit Griff mit Abdeckung</b> Spare WC brush incl. handle with vessel cover	39,00	131567054c	102313075 104113015 104113105	 <b>Ersatz-WC Bürste mit Griff</b> Spare WC brush with handle	19,00	131567031
102313057 102313066 104113012 104113102 104836012 104913092 104913112 104913122 104913152	 <b>Ersatz-WC Bürste ohne Griff</b> Spare WC brush without handle	10,00	131567008	102313079 104113019 104113109	 <b>Ersatz-WC Bürste mit Griff</b> Spare WC brush with handle	19,00	131567031c
104313067 102313056 104113017 104113107 104836012 104913092 104913117 104913122 104913152	 <b>Ersatz-WC Bürste ohne Griff</b> Spare WC brush without handle	10,00	131567008c	102313055 102313065 102313075 104113015 104113105	 <b>Ersatz-WC Bürste ohne Griff</b> Spare WC brush without handle	10,00	131567008
104113102 104113107 104113012 104113017	 <b>Ersatz-Glasschale für WC-Bürste, matt</b> Glass dish for WC brush, frosted	12,00	131567003	102313059 102313069 102313079 104113019 104113109	 <b>Ersatz-WC Bürste ohne Griff</b> Spare WC brush without handle	10,00	131567008c
104108042 138108191	 <b>Ersatz-Glaseifenschale, matt</b> Soap dish, frosted	11,00	131567002m	104113015 104113019 104113105 104113109	 <b>Ersatz-Glasschale für WC-Bürste, matt</b> Glass dish for WC brush, frosted	12,00	131567003
104110012 104110012 104110042 138110061	 <b>Ersatz-Glasbecher, matt</b> Glass cup, frosted	11,00	131567001m	104108045	 <b>Ersatz-Glaseifenschale, matt</b> Soap dish, frosted	11,00	131567002m
104109017 104019012	 <b>Ersatz-Glas für Seifenspender, matt</b> Glass for soap dispenser, frosted	49,00	131567243	104110015 104210025	 <b>Ersatz-Glasbecher, matt</b> Glass cup, frosted	11,00	131567001m
104109102 104109182	 <b>Ersatz-Glas für Seifenspender, matt</b> Glass for soap dispenser, frosted	23,00	131567111	104109016	 <b>Ersatz-Glas für Seifenspender, matt</b> Glass for soap dispenser, frosted	49,00	131567243
				104109115	 <b>Ersatz-Glas für Seifenspender, matt</b> Glass for soap dispenser, frosted	23,00	131567111
				104109035	 <b>Ersatz-Pumpe für Seifenspender</b> Spare pump complete, chrome	32,00	131567156
				104109015 104109016 104109115	 <b>Ersatz-Pumpe für Seifenspender</b> Spare pump complete, chrome	33,00	131567205

■B ERSATZTEILE/SPARE PARTS

Produkt Product	Ersatzteil Spare part	Preis € Price €	Bestellnummer Ordering number
104102045	 <b>Ersatz-Glas für Ablage, matt</b> Glass for shelf, frosted	18,00	131567011
104102045	 <b>Ersatz-Glas für Ablage, matt</b> Glass for shelf, frosted	16,00	131567066
104102015	 <b>Ersatz-Glas für Ablage, Eckmodell, matt</b> Glass for corner shelf, frosted	16,00	131567047
<b>CORAL / AMBER</b>			
158113017 158313067 155113017 155313067	 <b>Ersatz-WC Bürste ohne Griff</b> Spare WC brush without handle	10,00	131567008
158113017 158313067 155113017 155313067	 <b>Ersatz-WC Bürste ohne Griff</b> Spare WC brush without handle	10,00	131567008c
158113017 155113017	 <b>Ersatz-Glasschale für WC-Bürste, matt</b> Glass dish for WC brush, frosted	12,00	131567003
158108042 155108042	 <b>Ersatz-Glaseifenschale, matt</b> Soap dish, frosted	11,00	131567002m
158110012 155110012	 <b>Ersatz-Glasbecher, matt</b> Glass cup, frosted	11,00	131567001m
158109102 155109102	 <b>Ersatz-Glas für Seifenspender, matt</b> Glass for soap dispenser, frosted	23,00	131567111
CORAL 158109102	 <b>Ersatz-Pumpe für Seifenspender</b> Spare pump complete	53,00	131567550
AMBER 155109102	 <b>Ersatz-Pumpe für Seifenspender</b> Spare pump complete	53,00	131567552
<b>BRILLO / SABLO</b>			
161113017 161313060 160113017 160313060	 <b>Ersatz-WC Bürste ohne Griff</b> Spare WC brush without handle	10,00	131567008c
161113017 161313060 160113017 160313060	 <b>Ersatz-WC Bürste ohne Griff</b> Spare WC brush without handle	10,00	131567008
161113017 160113017	 <b>Ersatz-Glasschale für WC-Bürste, matt</b> Glass dish for WC brush, frosted	12,00	131567003
161108042 160108042	 <b>Ersatz-Glaseifenschale, matt</b> Soap dish, frosted	11,00	131567002m
161110012 160110012	 <b>Ersatz-Glasbecher, matt</b> Glass cup, frosted	11,00	131567001m
161109102 160109102	 <b>Ersatz-Glas für Seifenspender, matt</b> Glass for soap dispenser, frosted	23,00	131567111
BRILLO 161109102	 <b>Ersatz-Pumpe für Seifenspender</b> Spare pump complete	48,00	131567584
SABLO 160109102	 <b>Ersatz-Pumpe für Seifenspender</b> Spare pump complete	48,00	131567583
<b>HEMATIT / GRAPHIT</b>			
159113017 159313067 156113017 156313067	 <b>Ersatz-WC Bürste ohne Griff</b> Spare WC brush without handle	10,00	131567008

Produkt Product	Ersatzteil Spare part	Preis € Price €	Bestellnummer Ordering number
159113017 159313067 156113017 156313067	 <b>Ersatz-WC Bürste ohne Griff</b> Spare WC brush without handle	10,00	131567008c
159113017 156113017	 <b>Ersatz-Glasschale für WC-Bürste, matt</b> Glass dish for WC brush, frosted	12,00	131567003
159108042 156108042	 <b>Ersatz-Glaseifenschale, matt</b> Soap dish, frosted	11,00	131567002m
159110012 156110012	 <b>Ersatz-Glasbecher, matt</b> Glass cup, frosted	11,00	131567001m
159109102 156109102	 <b>Ersatz-Glas für Seifenspender, matt</b> Glass for soap dispenser, frosted	23,00	131567111
HEMATIT 159109102	 <b>Ersatz-Pumpe für Seifenspender</b> Spare pump complete	53,00	131567549
GRAPHIT 156109102	 <b>Ersatz-Pumpe für Seifenspender</b> Spare pump complete	53,00	131567551
<b>WHITE / DARK</b>			
104913094 104113014	 <b>Ersatz-WC Bürste mit Griff</b> Spare WC brush with handle	21,00	131567162
104113010 104913090	 <b>Ersatz-WC Bürste mit Griff</b> Spare WC brush with handle	21,00	131567404
102313060	 <b>Ersatz-WC Bürste mit Griff mit Abdeckung</b> Spare WC brush incl. handle with vessel cover	43,00	131567354
104913094 102313064 104113014	 <b>Ersatz-WC Bürste ohne Griff</b> Spare WC brush without handle	10,00	131567008
104913094 102313064 104113014 102313060 104113010 104913090	 <b>Ersatz-WC Bürste ohne Griff</b> Spare WC brush without handle	10,00	131567008c
WHITE 104913094	 <b>Ersatz-WC Bürste ohne Griff</b> Spare WC brush without handle	7,00	131567384c
104113014 104113010	 <b>Ersatz-Glasschale für WC-Bürste, matt</b> Glass dish for WC brush, frosted	12,00	131567003
104108044 104108040	 <b>Ersatz-Glaseifenschale, matt</b> Soap dish, frosted	11,00	131567002m
104110014 104110010	 <b>Ersatz-Glasbecher, matt</b> Glass cup, frosted	11,00	131567001m
104109014 104109010	 <b>Ersatz-Glas für Seifenspender, matt</b> Glass for soap dispenser, frosted	49,00	131567243
104109104 104109100	 <b>Ersatz-Glas für Seifenspender, matt</b> Glass for soap dispenser, frosted	23,00	131567111
104109014 104109104	 <b>Ersatz-Pumpe für Seifenspender</b> Spare pump complete, white	31,00	131567409
104109010 104109100	 <b>Ersatz-Pumpe für Seifenspender</b> Spare pump complete, chrome	31,00	131567239
104102040	 <b>Ersatz-Glas für Ablage, matt</b> Glass for shelf, frosted	18,00	131567011











Produkt Product	Ersatzteil Spare part	Preis € Price €	Bestellnummer Ordering number
<b>OBLA / STELLA</b>			
165113012 166113012	 <b>Ersatz-WC Bürste mit Griff</b> Spare WC brush with handle	19,00	131567009
165113012 166113012	 <b>Ersatz-WC Bürste ohne Griff</b> Spare WC brush without handle	10,00	131567008
165113012 166110012	 <b>Glasschale für WC-Bürste</b> Glass dish for WC brush	12,00	131567003
165108042 166108042	 <b>Glasseifenschale, matt</b> Glass soap dish, frosted	14,00	131567716
165110012 166109017	 <b>Glasbecher, matt</b> Glass cup, frosted	14,00	131567717
165109017 166109017	 <b>Glas für Seifenspender, matt</b> Glass for soap dispenser, frosted	14,00	131567724
165109017 165109017	 <b>Pumpe, komplett</b> Spare pump, complete	42,00	131567765
<b>CIRCUM / QUADRA</b>			
168113012 169113012	 <b>Ersatz-WC Bürste mit Griff</b> Spare WC brush with handle	8,00	131567764
168113012 169113012	 <b>Ersatz-WC Bürste ohne Griff</b> Spare WC brush without handle	3,00	131567767
168113012 169113012	 <b>Glasschale für WC-Bürste</b> Glass dish for WC brush	7,00	131567736
168108042 169108042	 <b>Glasseifenschale, matt</b> Glass soap dish, frosted	4,00	131567742
168110012 169110012	 <b>Glasbecher, matt</b> Glass cup, frosted	4,00	131567743
168109017 169109017	 <b>Glas für Seifenspender, matt</b> Glass for soap dispenser, frosted	5,00	131567739
168109017 169109017	 <b>Pumpe, komplett</b> Spare pump, complete	13,00	131567763
<b>NERO</b>			
135013010	 <b>Ersatz-WC Bürste mit Griff</b> Spare WC brush with handle	25,00	131567365
135913090 135013010	 <b>Ersatz-WC Bürste ohne Griff</b> Spare WC brush without handle	7,00	131567384c
135913160	 <b>Ersatz-WC Bürste ohne Griff</b> Spare WC brush without handle	9,00	131567282
135013010	 <b>Ersatz-Glasschale für WC-Bürste, matt</b> Glass dish for WC brush, frosted	20,00	131567253
135008020	 <b>Ersatz-Glasseifenschale, matt</b> Soap dish, frosted	13,00	131567250
135011010	 <b>Ersatz-Glasbecher, matt</b> Glass cup, frosted	13,00	131567249
135009040	 <b>Ersatz-Glas für Seifenspender, matt</b> Glass for soap dispenser, frosted	19,00	131567251
135009040	 <b>Ersatz-Pumpe für Seifenspender</b> Spare pump complete, chrome	31,00	131567239
135002240	 <b>Ersatz-Glas für Ablage, matt</b> Glass for shelf, frosted	33,00	131567254

Produkt Product	Ersatzteil Spare part	Preis € Price €	Bestellnummer Ordering number
<b>VIA</b>			
118113092	 <b>Ersatz-WC Bürste mit Griff mit Abdeckung</b> Spare WC brush incl. handle with vessel cover	58,00	131567277
135013012	 <b>Ersatz-WC Bürste mit Griff mit Abdeckung</b> Spare WC brush incl. handle with vessel cover	18,00	131567386
118113092	 <b>Ersatz-WC Bürste ohne Griff</b> Spare WC brush without handle	10,00	131567281
118113092	 <b>Ersatz-WC Bürste ohne Griff</b> Spare WC brush without handle	10,00	131567282
135913091	 <b>Ersatz-WC Bürste ohne Griff</b> Spare WC brush without handle	7,00	131567384c
118213092	 <b>Ersatz-WC Bürste ohne Griff</b> Spare WC brush without handle	7,00	131567012c
135013012	 <b>Ersatz-Glasschale für WC-Bürste, matt</b> Glass dish for WC brush, frosted	20,00	131567253
135008022	 <b>Ersatz-Glasseifenschale, matt</b> Soap dish, frosted	13,00	131567250
135011012	 <b>Ersatz-Glasbecher, matt</b> Glass cup, frosted	13,00	131567249
135009042	 <b>Ersatz-Glas für Seifenspender, matt</b> Glass for soap dispenser, frosted	19,00	131567251
135009042	 <b>Ersatz-Pumpe für Seifenspender</b> Spare pump complete, chrome	32,00	131567204
135002242	 <b>Ersatz-Glas für Ablage, matt</b> Glass for shelf, frosted	33,00	131567254
<b>SOLO</b>			
139113142	 <b>Ersatz-WC Bürste mit Griff</b> Spare WC brush with handle	18,00	131567417
139113142	 <b>Ersatz-WC Bürste ohne Griff</b> Spare WC brush without handle	10,00	131567049
135913162	 <b>Ersatz-WC Bürste ohne Griff</b> Spare WC brush without handle	9,00	131567282
139113142	 <b>Ersatz-Glasschale für WC-Bürste, matt</b> Glass dish for WC brush, frosted	25,00	131567123
139108032	 <b>Ersatz-Glasseifenschale, matt</b> Soap dish, frosted	13,00	131567250
139110012	 <b>Ersatz-Glasbecher, matt</b> Glass cup, frosted	13,00	131567249
139109042	 <b>Ersatz-Glas für Seifenspender, matt</b> Glass for soap dispenser, frosted	19,00	131567251
139109042	 <b>Ersatz-Pumpe für Seifenspender</b> Spare pump complete, chrome	31,00	131567063
139102312	 <b>Ersatz-Glas für Ablage, matt</b> Glass for shelf, frosted	15,00	131567104
<b>GAMMA</b>			
145713324	 <b>Ersatz-WC Bürste mit Griff mit Abdeckung</b> Spare WC brush incl. handle with vessel cover	23,00	131567459
145613320	 <b>Ersatz-WC Bürste mit Griff mit Abdeckung</b> Spare WC brush incl. handle with vessel cover	23,00	131567474

•B ERSATZTEILE/SPARE PARTS







Produkt Product	Ersatzteil Spare part	Preis € Price €	Bestellnummer Ordering number
145413092 145613310 145513092 145713314	 <b>Ersatz-WC Bürste ohne Griff</b> Spare WC brush without handle	10,00	131567008
145413092 145613310 145513092 145713314	 <b>Ersatz-WC Bürste ohne Griff</b> Spare WC brush without handle	10,00	131567008c
145513092 145713314	 <b>Behälter für Toilettenbürste</b> Spare bowl for WC brush	79,00	131567450
145613320	 <b>Behälter für Toilettenbürste</b> Spare bowl for WC brush	60,00	131567451
145613320	 <b>Behälter für Toilettenbürste</b> Spare bowl for WC brush	60,00	131567453
145609320 145709324	 <b>Ersatzpumpe inkl. Behälter für Seifenspender</b> Spare pump complete incl. containers, chrome	27,00	131567457
145609310 145709314 145409012 145509012	 <b>Pumpe, komplett</b> Spare pump, complete	43,00	131567456

**NIKI**

153113012	 <b>Ersatz-WC Bürste mit Griff</b> Spare WC brush with handle	19,00	131567009
153113012	 <b>Ersatz-WC Bürste mit Griff</b> Spare WC brush with handle	19,00	131567009c
153113012	 <b>Ersatz-WC Bürste ohne Griff</b> Spare WC brush without handle	10,00	131567008
153113012	 <b>Ersatz-WC Bürste ohne Griff</b> Spare WC brush without handle	10,00	131567008c
153113012	 <b>Ersatz-Glasschale für WC-Bürste, matt</b> Glass dish for WC brush, frosted	22,00	131567372
153108022	 <b>Ersatz-Glasseifenschale, matt</b> Soap dish, frosted	11,00	131567370
153110052	 <b>Ersatz-Glasbecher, matt</b> Glass cup, frosted	11,00	131567368
153209049	 <b>Ersatz-Glas für Seifenspender, matt</b> Glass for soap dispenser, frosted	26,00	131567371
153209049	 <b>Ersatz-Pumpe für Seifenspender</b> Spare pump complete, chrome	10,00	131567369
153102042	 <b>Ersatz-Glas für Ablage, matt</b> Glass for shelf, frosted	10,00	131567179

**BETA**









132113012	 <b>Ersatz-WC Bürste mit Griff</b> Spare WC brush with handle	19,00	131567009
132113017	 <b>Ersatz-WC Bürste mit Griff</b> Spare WC brush with handle	19,00	131567009c
132113012	 <b>Ersatz-WC Bürste ohne Griff</b> Spare WC brush without handle	10,00	131567008
132113017	 <b>Ersatz-WC Bürste ohne Griff</b> Spare WC brush without handle	10,00	131567008c
132108042	 <b>Ersatz-Glasseifenschale, matt</b> Soap dish, frosted	11,00	131567002m

Produkt Product	Ersatzteil Spare part	Preis € Price €	Bestellnummer Ordering number
132110012 132110022 132110042	 <b>Ersatz-Glasbecher, matt</b> Glass cup, frosted	11,00	131567001m
132109017	 <b>Ersatz-Glas für Seifenspender, matt</b> Glass for soap dispenser, frosted	49,00	131567243
132109102 132109182	 <b>Ersatz-Glas für Seifenspender, matt</b> Glass for soap dispenser, frosted	23,00	131567111
132102042 132102212	 <b>Ersatz-Glas für Ablage, matt</b> Glass for shelf, frosted	18,00	131567011
132102012	 <b>Ersatz-Glas für Ablage, Eckmodell, matt</b> Glass for corner shelf, frosted	16,00	131567047
132109017 132109102 132109182	 <b>Ersatz-Pumpe für Seifenspender</b> Spare pump complete, chrome	32,00	131567204

**EASY / EASY01**

163113065 164113065	 <b>Ersatz-WC Bürste mit Griff</b> Spare WC brush with handle	28,00	131567772
163113061 164113061	 <b>Ersatz-WC Bürste mit Griff</b> Spare WC brush with handle	32,00	131567773
163113060 164113060	 <b>Ersatz-WC Bürste mit Griff</b> Spare WC brush with handle	34,00	131567774



**ALFA / NOX**

ALFA 102413012	 <b>Ersatz-WC Bürste mit Griff</b> Spare WC brush with handle	18,00	131567018
ALFA 102413012	 <b>Ersatz-WC Bürste mit Griff</b> Spare WC brush with handle	18,00	131567018c
ALFA 102413012	 <b>Ersatz-WC Bürste ohne Griff</b> Spare WC brush without handle	7,00	131567012
102413012 102413010	 <b>Ersatz-WC Bürste ohne Griff</b> Spare WC brush without handle	7,00	131567012c
102413012 102413010	 <b>Ersatz-Glasschale für WC-Bürste, matt</b> Glass dish for WC brush, frosted	13,00	131567113
102408023 102408030	 <b>Ersatz-Glasseifenschale, matt</b> Soap dish, frosted	11,00	131567002m
102410012 102410010	 <b>Ersatz-Glasbecher, matt</b> Glass cup, frosted	12,00	131567378
102408022 102408020	 <b>Ersatz-Glas für Seifenspender, matt</b> Glass for soap dispenser, frosted	13,00	131567380
ALFA 102408022	 <b>Ersatz-Pumpe für Seifenspender</b> Spare pump complete, chrome	14,00	131567382
NOX 102408020	 <b>Ersatz-Pumpe für Seifenspender</b> Spare pump complete, chrome	14,00	131567673
102402242	 <b>Ersatz-Glas für Ablage, matt</b> Glass for shelf, frosted	17,00	131567191

**RETRO**

144213018 144313012	 <b>Ersatz-WC Bürste mit Griff</b> Spare WC brush with handle	19,00	131567009
144113017	 <b>Ersatz-WC Bürste mit Griff</b> Spare WC brush with handle	25,00	131567172

Produkt Product	Ersatzteil Spare part	Preis € Price €	Bestellnummer Ordering number
144213018 144313012	 <b>Ersatz-WC Bürste mit Griff</b> Spare WC brush with handle	19,00	131567009c
144113017	 <b>Ersatz-WC Bürste mit Griff</b> Spare WC brush with handle	18,00	131567420
144113017 144213018 144313012	 <b>Ersatz-WC Bürste ohne Griff</b> Spare WC brush without handle	10,00	131567008
144113017 144213018 144313012	 <b>Ersatz-WC Bürste ohne Griff</b> Spare WC brush without handle	10,00	131567008c
144113017 144213018 144313012	 <b>Ersatz-Glasschale für WC-Bürste, matt</b> Glass dish for WC brush, frosted	12,00	131567003
144108027 144208028 144308022	 <b>Ersatz-Glasseifenschale, matt</b> Soap dish, frosted	11,00	131567002m
144110017 144110027 144210018 144210028 144310012 144310022	 <b>Ersatz-Glasbecher, matt</b> Glass cup, frosted	11,00	131567001m
144109017 144209018 144309012	 <b>Ersatz-Glas für Seifenspender, matt</b> Glass for soap dispenser, frosted	49,00	131567243
144109107 144209108 144309102	 <b>Ersatz-Glas für Seifenspender, matt</b> Glass for soap dispenser, frosted	23,00	131567111
144109017 144109107	 <b>Ersatz-Pumpe für Seifenspender</b> Spare pump complete, chrome	40,00	131567441
144309012 144209018 144309102 144209108	 <b>Ersatz-Pumpe für Seifenspender</b> Spare pump complete, chrome	34,00	131567442
<b>VISTA</b>			
120113316	 <b>Ersatz-WC Bürste ohne Griff</b> Spare WC brush without handle	10,00	131567464
120109016	 <b>Ersatz-Pumpe für Seifenspender</b> Spare pump complete, chrome	15,00	131567473

Produkt Product	Ersatzteil Spare part	Preis € Price €	Bestellnummer Ordering number
<b>SILIKON</b>			
	 <b>WC Silikonbürste mit Griff</b> WC silicone brush with handle	20,00	131567448
TASI 154113012, OMEGA 104113102, 104113012, 104836012, 104913152, 104913122, 104913112, 104913092, 104113017, 104913112, 104913122, 104913117, 104913092, 104113107, BETA 132113012, 132113017, VIA 135013012, NIKI 153113012, ALFA 102413012, 132836012			
	 <b>WC Silikonbürste ohne Griff</b> Spare WC silicone brush without handle	14,00	131567447
DARK 102313060, 104113010, KERA 144713017, TASI 154113012, OMEGA 102313066, 104113012, 104913152, 104913122, 104913117, 104913112, 104913092, 104913090, 104113107, 102313057, BETA 132113012, 132113017, RETRO CHROM 144313012, RETRO BRONZ 144113017, RETRO GOLD 144213018, NIKI 153113012, 104836012, 132836012			
<b>GUMA</b>			
	 <b>Gummiabdeckung</b> Rubber cover	4,00	131567411
ORGANIC BLACK 167113060, OMEGA 104113107, 104113017, 104913152, 104913122, 104913117, 104913092, NEO 104113109, 104113019, 102313079, CORAL 1581130107, AMBER 155113017, HEMATIT 159113017, GRAPHIT 156113017			

**Ersatz-WC Bürste ohne Griff**

Spare WC brush without handle

70×100×70 mm

131567447

**Ersatz-WC Bürste mit Griff**

Spare WC brush with handle

70×355×70 mm

131567448

7,5 €

20,00 €

# ZUBEHÖR

ACCESSORIES



## Kleber - Set für Bad-Accessoires

Adhesive set bathroom accessories

80×140×25 mm

199352010

13,00 €

## Kleber - Set für Bad-Accessoires

Quadra, Circum

Adhesive set bathroom accessories Quadra, Circum

199352012

10,00 €

## Edelstahlreiniger

Cleaner for stainless steel

95×250×60 mm, 500 ml

79170177

35,00 €

### Verwendbar für:

Usable for:

OBLA, STELLA, OMEGA, BETA, NEO,  
WHITE, DARK, HEMATIT, GRAFIT, CORAL,  
AMBER, BRILO, SABLO

# Bemeta-Kataloge

Catalogues Bemeta



Den Katalog mit unserem kompletten Angebot finden Sie unter [www.bemeta.cz](http://www.bemeta.cz)

Check out the catalog with our complete offer at [www.bemeta.cz](http://www.bemeta.cz)

**Änderungen der Produkten, Preisen, Design und Informationen vorbehalten.**

**Informationen und Ansichten entsprechen dem Zeitpunkt der Ausgabe vom Katalog.**

**Für Druckfehler tragen wir keine Verantwortung.**

Changes in products, prices, design and informations reserved.

Informations and images are corresponding to the time of the catalog publication. Errors and misprints excepted.

DE - 1/2026



**HYPOPAN GmbH**

Margarethenstraße 29  
56566 Neuwied  
Deutschland/Germany

Tel.: ++49 (0) 2622/9229605

Fax: ++49 (0) 2622/902757

GSM: ++49 (0) 170/7909828

■ [www.hypopan.de](http://www.hypopan.de)

■ [vertrieb@hypopan.de](mailto:vertrieb@hypopan.de)



**BEMETA DESIGN s. r. o.**

Žatčany 28  
664 53 Czech Republic

[www.bemeta.cz](http://www.bemeta.cz)

